



Made
in
Germany

1

EIBENSTOCK

MENGMACHINES

MENGSTANGEN

HANDBOORMACHINES

DIAMANTBOORMACHINES

BOORSTATIEVEN

POLIJST- & PLEISTERBEWERKINGSMACHINE

BETONSLIJPERS

RENOVATIEFREESMACHINES

SCHUURMACHINES

DIAMANTZAAG

HAAKSE SLIJPER

SLEUVENZAAGMACHINE

ZAAGMACHINE MET DUBBEL BLAD

INDUSTRIËLE ZUIGERS

MACHINES À MALAXER

MALAXEURS

PERCEUSES À MAIN

MACHINES DE FORAGE DIAMANT

BÂTIS DE FORAGE

POLISSEUSE & TALOCHEUSE ÉLECTRIQUE

PONCEUSES À BÉTON

FRAISEUSES DE RÉNOVATION

PONCEUSES

SCIE DIAMANTÉE

MEULEUSE D'ANGLE

RAINUREUSE

DÉCOUPEUSE À LAME DOUBLE

ASPIRATEURS INDUSTRIELS



EIBENSTOCK
Power Tools



SYMBOLIEK / SYMBOLIQUE

	Vermogen Puissance		Kabellengte Longueur de câble		Gewicht Poids		Toerental Tour par minute		Compatibel met stofzuiger Compatible avec aspirateur
--	------------------------------	--	---	--	-------------------------	--	-------------------------------------	--	--

Mengstangen • Malaxeurs

	Aansluiting Raccord		Maximale capaciteit Capacité maximale		Max. Ø		Incl. mengstang Mélangeur incl.		incl. speciale mengstang Mélangeur spécial incl.
	Verven, primers, lakken Peintures, primers, laques		Kant- en klaremortel Mortier-collé, ciment		Tegellijmen Colles carrelage		Gips, voegspecie, crépi Plâtre, enduit, crépi		Epoxyharsen, bitumencoatings Résine epoxy, revêtements de bitumes

Boor- en schroefmachines • Perceuses et visseuses

	Gereedschapshouder Porte-outils		Spanflens Bride de serrage		Onbelaste draaisnelheid Vitesse de rotation à vide		Nominale draaisnelheid Vitesse de rotation nominale		Max. boordiameter Diamètre de forage max.
	Rechts- en linksdraaiend Rotation bi-directionnelle								

Diamantboortechieken • Techniques de forage diamanté

	Nominale draaisnelheid Vitesse de rotation nominale		Aansluiting Raccord		Gereedschapshouder Porte-outils		Kabel in Polyurethaan Cable en Polyuréthane		Max. Ø in gewapend beton met boorstatief Ø max. dans le béton armé avec bati de forage
	Nominale draaisnelheid in beton Vitesse de rotation nominale dans le béton		Nominale draaisnelheid in baksteen Vitesse de rotation nominale dans la brique		Max. Ø in baksteen met droog gebruik Ø max. dans la brique avec utilisation à sec		Max. Ø in gewapend beton met droog en nat gebruik Ø max. dans le béton armé utilisation à sec et à eau		

Boorstatieven • Bâts de forage

	Max. Ø aan 90° Ø max. à 90°		Kolomlengte Longueur de colonne		Spanhals Collier de serrage		Max. helling Inclinaison max.		Voetafmetingen Dimension du pied
	Vacuüm Sous vide		Aansluiting machine / statief Raccord machine / bâti		Aansluiting machine / statief Raccord machine / bâti				

Schuur-, polijst- en zaagmachines • Machines à poncer, à polir et à couper

	Max. Ø Ø max.		Nominale draaisnelheid Vitesse de rotation nominale		Gereedschapshouder Porte-outils		Onbelaste draaisnelheid Vitesse de rotation à vide		Nominale draaisnelheid Vitesse de rotation nominale
	Max. snijlengte Longueur de coupe max.		Max. snijlengte Longueur de coupe max.		Max. snijdikte Épaisseur de coupe max.		Onbelaste draaisnelheid Vitesse de rotation à vide		Nominale draaisnelheid Vitesse de rotation nominale
	Zaagbladlengte Longueur de la lame		Aantal slagen per min. Nombre de coups par min.		Accu type Type de batterie				

Industriële stofzuigers • Aspirateurs industriels

	Max. capaciteit - stof Capacité max. - poussière		Max. capaciteit - nat Capacité max. - eau		Max. zuigkracht Aspiration max.		Filteroppervlakte Surface du filtre		Afmetingen van stofzuiger Dimensions de l'aspirateur
--	--	--	---	--	---	--	---	--	--

BASIC LINE

EE 0B711
MXT 110 B

	1100W 230V
	0 - 500 / min RPM
	3 m H07RN-F
	M14
	40 kg MAX
	120 mm MAX
	3,5 kg
	Ø 120 mm • EE 31224 INCL.



code							min.	€
EE 0B711		4026851008725	1100 Watt	6,540 kg	30	1	1	198,00

PRO LINE

EE 077E5
EHR 15.2 SB

	1050W 230V
	0 - 450 / min
	3 m H07RN-F
	M14
	40 kg
	120 mm
	3,1 kg
	• Ø 120 mm EE 31224



EHR 15.2 SB

EE 07779P
EHM 162 S

	2000W 230V
	0 - 430 / min
	3 m H07BQ-F
	M14
	80 kg
	180 mm
	7,2 kg
	• Ø 160 mm EE 31327

EE 10070
EHM 162 S

	2000W 230V
	0 - 430 / min
	3 m H07BQ-F
	M14
	80 kg
	180 mm
	7,2 kg
	• Ø 180 mm FC 073428



Kabel / Cable
PUR



EHM 162 S



code							min.	€
EE 077E5		4026851017413	1050 Watt	5,880 kg	40	1	1	285,00
EE 07779P		4026851012340	2000 Watt	8,460 kg	40	1	1	431,00
EE 10070		4026851012708	2000 Watt	8,560 kg	30	1	1	434,00

PRO LINE

EE 077E2 EHR 20/2.6 S		EE 077E3 EHR 23/2.5 S		EE 10060 EHR 23/2.5 S		EE 0774W EZR 24 R R/L	
	1300W 230V		1800W 230V		1800W 230V		1800W 230V
	0 - 250 / min 0 - 450 / min		0 - 250 / min 0 - 580 / min		0 - 250 / min 0 - 580 / min		180 - 440 / min
	3 m H07BQ-F		3 m H07BQ-F		3 m H07BQ-F		3 m H07BQ-F
	M14		M14		M14		Special
	50 kg		80 kg		80 kg		80 kg
	150 mm		180 mm		180 mm		230 mm
	5,1 kg		6,9 kg		6,9 kg		11,7 kg
	Ø 140 mm EE 31326		Ø 160 mm EE 31327		Ø 180 mm FC 073428		Ø 230 mm EE 31630

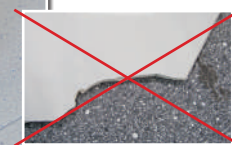
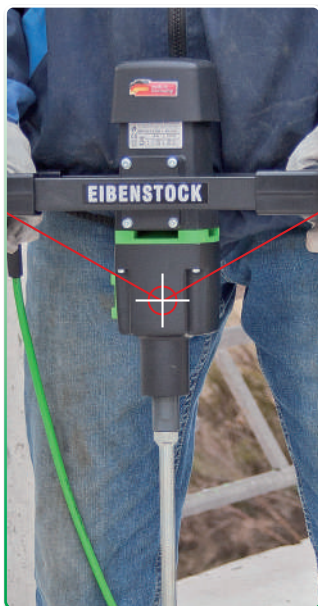

code							min.	€
EE 077E2		4026851016218	1300 Watt	8,360 kg	15	1	1	458,00
EE 077E3		4026851016263	1800 Watt	10,480 kg	20	1	1	520,00
EE 10060		5420000032231	1800 Watt	10,580 kg	30	1	1	546,00
EE 0774W		4026851018441	1800 Watt	14,820 kg	-	1	1	746,00

EE 07614
AUTOMIX 1801

EE 07623
TWINMIX 1800T

	1500W 230V	1800W 230V
	50 min ⁻¹	a 250/450 min ⁻¹ b 20/36 min ⁻¹
	3 m H07RN-F	3 m H07RN-F
	M20	M14 / Special
	65 L 50 kg	65 L 50 kg
	26,5 kg	70,0 kg
	EE 31440	a & b

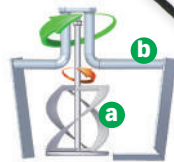

EE 32341

code							min.	€
EE 07614		4026851008206	1500 Watt	28,500 kg	4	1	1	979,00
EE 07623		4026851016119	1800 Watt	74,000 kg	-	1	1	2555,00
Mengstang voor AUTOMIX 1801 • Malaxeur pour AUTOMIX 1801								
EE 31440		4026851006066	M20	2,170 kg	-	1	1	112,00
Kuip voor AUTOMIX 1801 / TWINMIX 1800T • Cuvelle pour AUTOMIX 1801 / TWINMIX 1800T								
EE 32341		4026851006080	65 L - 57,5 X 34 cm	2,100 kg	-	1	1	17,80

EE 07625
FLOORMIX 2300

	2300W 230V
	70/130/160/280 min ⁻¹
	0,20 m H07RN-F
	M16
	110 L 150 kg
	48,0 kg
	compatibel



- Voor egalisiemortels
Pour mortiers d'égalisation

code							min.	€
EE 07625		4026851016355	2300 Watt	52,000 kg	-	1	1	2032,00



Mengstang type R/RG - speciaal voor dunne, vloeibare materialen (verven, lakken, primers)

Malaxeur type R/RG - idéal pour matériaux liquides et peu consistants (peintures, vernis, primers)



code			Schacht Tige	Ø mm	↔ mm	kg				min.	€
Hexagonaal • Hexagonale											
EE 31111	vrac	4026851001719	8	70	400	10	0,262 kg	-	1	1	7,50
EE 31112	vrac	4026851001726	8	85	400	15	0,264 kg	-	1	1	9,50
EE 31113	vrac	4026851001733	10	100	600	20	0,623 kg	-	1	1	11,80
EE 31114	vrac	4026851001740	10	120	600	25	0,699 kg	-	1	1	14,20
M14 • M14											
EE 31124	vrac	4026851001764	14	120	600	25	1,042 kg	-	1	1	18,90



Mengstang type W/WG - speciaal voor kleverige en dikvloeibare materialen (teggelijmen, kant - en klaarmortel, voegspecie)

Malaxeur type W/WG - idéal pour matériaux collants et pâteux (colle carrelage, mortier-colle, enduit, ciment)



code			Schacht Tige	Ø mm	↔ mm	kg				min.	€
Hexagonaal • Hexagonale											
EE 31212	vrac	4026851001788	8	85	400	8	0,320 kg	-	1	1	10,00
EE 31214	vrac	4026851001801	10	120	600	20	0,849 kg	-	1	1	21,30
M14 • M14											
EE 31224	vrac	4026851001856	14	120	600	20	1,167 kg	-	1	1	23,70
EE 31225	vrac	4026851001818	14	135	600	50	1,274 kg	-	1	1	27,30
EE 31227	vrac	4026851001870	14	160	600	80	1,622 kg	-	1	1	34,80



Mengstang type M/MG - speciaal voor zware en dikvloeibare materialen (gipsen, pleisters, mortel, spachtels)

Malaxeur type M/MG - idéal pour matériaux lourds et crémeux (plâtres, mortiers, crépi)

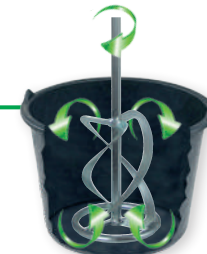

code			Schacht Tige	Ø mm	↔ mm	kg				min.	€
Hexagonaal • Hexagonale											
EE 31314	vrac	4026851001887	12	120	600	25	1,004 kg	-	1	1	23,70
M14 • M14											
EE 31324	vrac	4026851001917	14	120	600	25	1,150 kg	-	1	1	26,00
EE 31326	vrac	4026851001924	14	140	600	50	1,292 kg	-	1	1	30,90
EE 31327	vrac	4026851001931	14	160	600	80	1,705 kg	-	1	1	36,00
EE 31328	vrac	4026851010896	14	180	600	80	1,630 kg	-	1	1	45,50

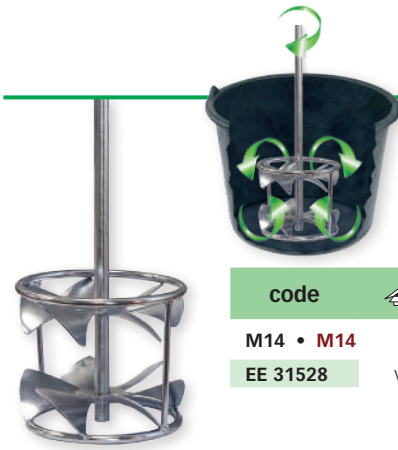

Mengstang type SGR - speciaal voor vloeibare en vloeibare materialen (dunbedmortel, vulmiddelen, nivelleermassa's, coatings en kleefstoffen)
Malaxeur type SGR - idéal pour matériaux liquides et coulants (mortiers-colles, enduits, produits de nivellement, revêtements et adhésifs)



code		Schacht Tige	Ø mm	mm	kg			min.	€
M14 • M14									
EE 31528	vrac	4026851018731	12	150	600	50	1,630 kg	- 1 1	54,70



Mengstang type LG - speciaal voor kleverige en vloeibare materialen (lijmen, epoxyharsen, bitumencoatings, gietmassa)
Malaxeur type LG - idéal pour matériaux collants et coulants (colles et joints, revêtements de bitumes, résine époxy)



code		Schacht Tige	Ø mm	mm	kg			min.	€
M14 • M14									
EE 31024	vrac	4026851004567	14	120	600	25	0,870 kg	- 1 1	16,60



Mengstang voor EZR 24 R R/L - EZR 23 R R/L - speciaal voor kleverige en vloeibare materialen (lijmen, epoxyharsen, bitumencoatings, gietmassa)
Malaxeur pour EZR 24 R R/L - EZR 23 R R/L - idéal pour matériaux collants et coulants (colles et joints, revêtements de bitumes, résine époxy)



code		Schacht Tige	Ø mm	mm	kg			min.	€
<i>Prijs per paar • Prix par paire</i>									
EE 31620	vrac	4026851010209	18	195	650	40	3,650 kg	- 1 1	116,00
EE 31610	vrac	4026851003096	18	210	650	60	3,850 kg	- 1 1	116,00
EE 31630	vrac	4026851015525	18	230	650	80	4,050 kg	- 1 1	114,00

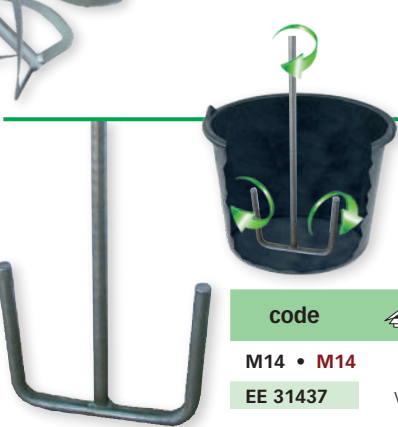

Mengstang type RPG - speciaal voor zware materialen (bitumen, leem, afdichtingsmaterialen)
Malaxeur type RPG - idéal pour les matériaux lourds (masses bitumeuses, mastics à sol)



code		Schacht Tige	Ø mm	mm	kg			min.	€
M14 • M14									
EE 31437	vrac	4026851003294	14	160	600	50	1,250 kg	- 1 1	17,60

Zie ook / Voir aussi **p.470 & p.471 PINGUIN**



Snelwisseladapter • Adaptateur à connexion rapide

code							min.	€
EE 32143	zakje/sachet	4026851010933	M14 - M14i	0,512 kg	-	1	1	57,90
EE 32144	zakje/sachet	4026851019400	-	0,120 kg	-	1	1	20,60
EE 32145		4026851011602	EE 32143 + EE 32144	0,654 kg	-	1	1	72,70



KOP • TÊTE
EIBENSTOCK



M14 - M14



AANSLUITING M14 x 2
RACCORD M14 x 2



TYPE MG - WG - LG - RG

Adapter voor mengmachine • Adaptateur pour malaxeur

code							min.	€
EE 32153		4026851002181	M14i - M14i	0,110 kg	-	1	1	14,20
EE 32173		4026851002198	M18i - M14i	0,120 kg	-	1	1	14,20
EE 32134		4026851010186	raccord SDS+ aansluiting - M14i	0,088 kg	-	1	1	25,60



EE 32173



EE 32134

KOP • TÊTE
FESTOOL



EE 32153
M14i - M14i



KOP • TÊTE
FLEX



EE 32173
M18i - M14i



KOP • TÊTE
Raccord SDS aansluiting



EE 32134
SDS+ - M14i
Aansluiting Raccord

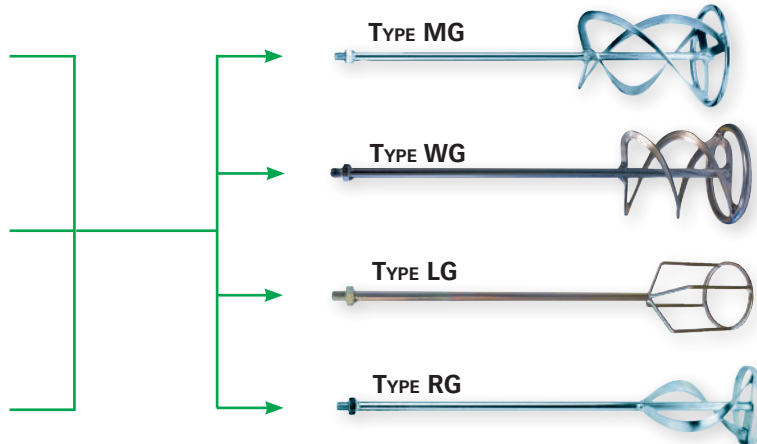

	EE 0122R EHB 16/2.5 S R/L	EE 0152H EHB 32/2.2 R-R/L	EE 0154A EHB 32/4.2
	1400W	1800W	1700W
	5/8" x 16 UN	MK3	MK3
	43 mm	65 mm	65 mm
	1: 650 / min 2: 1200 / min	1: 60-140 / min 2: 200-470 / min	1: 215 / min 2: 330 / min 3: 460 / min 4: 680 / min
	0 - 400 / min 0 - 750 / min	1: 60-140 / min 2: 200-470 / min	1: 110 / min 2: 175 / min 3: 245 / min 4: 385 / min
	65 mm (Wood) 28 mm (Alu) 20 mm (Steel)	100 mm (Wood) 60 mm (Alu) 32 mm (Steel)	100 mm (Wood) 60 mm (Alu) 32 mm (Steel)
	3 m H07RN-F	3 m H07RN-F	3 m H07RN-F
	4,5 kg	6,4 kg	6,9 kg



EHB 16/2.5 S R/L



EHB 32/2.2 R-R/L



EHB 32/4.2



code						min.	€
EE 0122R		4026851018694	1400 Watt	6,750 kg	-	1 1	460,00
EE 0152H		4026851002570	1800 Watt	8,460 kg	-	1 1	723,00
EE 0154A		4026851002549	1700 Watt	8,900 kg	-	1 1	578,00



Toebehoren voor handboormachines
Accessoires pour perceuses à main

code						min.	€
Magnetische boorhouder - B32.1 • Support magnétique pour perceuse - B32.1							
EE 09507		4026851015228	Voor / Pour EHB 32/2.2 R/R/L + EHB 32/4.2	17,000 kg	-	1 1	978,00

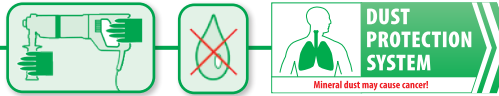

EE 03E11
EHD 1500

	1500W 230V
	3700 min⁻¹ R P M
	0-2000 min⁻¹ R P M
	32 - 82 mm
	M18
	46 mm
	3 m H07BQ-F PUR Kabel / Cable
	3,9 kg



EE 03E11

LED indicator
Vervang de koolborstels -
Service-LED lampje brandt
ongeveer 10 uur voor
uitvallen.
Indicateur LED
Remplacer les charbons
Service LED s'allume environ
10 heures avant l'arrêt.



- Mechanische veiligheidskoppeling.
Embrayage de sécurité mécanique.
- Verstelbare handgreep.
Poignée ajustable.
- Elektronische overbelastings-
beveiliging en temperatuurcontrole,
zachte aanloop.
Protection électronique de
surcharge et contrôle de la
température démarrage progressif.



code							min.	€
EE 03E11	koffer/coffre	4026851016157	1500 Watt	7,540 kg	-	1	1	488,00

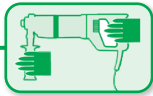

NEW

EE 03E28 EHD 2002 S

	1800W 230V
	1 : 1500 min⁻¹ 2 : 3000 min⁻¹ R P M
	1 : 0-850 min⁻¹ 2 : 0-1700 min⁻¹ R P M
	32 - 132 mm MAX Ø
	M18
	53 mm
	3 m H07BQ-F PUR Kabel / Cable
	5,9 kg



- Mechanische veiligheidskoppeling.
Embrayage de sécurité mécanique.
- Verstelbare handgreep.
Poignée ajustable.
- Elektronische overbelastings beveiliging en temperatuurcontrole, zachte aanloop.
Protection électronique de surcharge et contrôle de la température démarrage progressif.
- Robuuste transmissie met 2 versnellingen
Transmission robuste à 2 vitesses



code							min.	€
EE 03E28	koffer/coffre	4026851019226	1800 Watt	9,600 kg	-	1	1	726,00



EE 03217
ESD 1801

	1800W 230V
	3000 min⁻¹
	0-2050 min⁻¹
	92 mm
	M18
	53 mm
	3 m H07RN-F
	5,9 kg



- Transmissie met schakelbare zachte slagen.
Transmission à percussion douce commutable.
- Hoge werksnelheid.
Grande vitesse de travail.
- Mechanische veiligheidskoppeling.
Embrayage de sécurité mécanique.
- Verstelbare handgreep.
Poignée ajustable.
- Elektronische overbelastingsbeveiliging en temperatuurcontrole, zachte aanloop.
Protection électronique de surcharge et contrôle de la température, démarrage progressif.
- Lock-on knop met bescherming tegen onopzettelijke vergrendeling.
Bouton de verrouillage avec protection contre le blocage involontaire.



code							min.	€
EE 03217	koffer/coffre	4026851009241	1800 Watt	12,340 kg	-	1	1	656,00
Stofafzuigingsunit H-SYSTEM • Système anti poussière H-SYSTEM								
DX 981215		5420000024014	M18(F) - M16(M)	0,383 kg	-	1	1	93,30

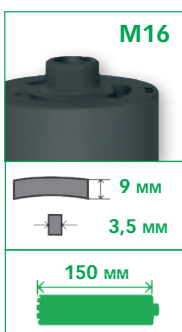

code								min.	€
Ø mm									
Diamantdroogboor M16 voor ESD 1801 • Couronne à sec diamanté M16 pour ESD 1801									
EE 36S051	vrac	4026851012128	51	7	0,300 kg	-	1	1	167,00
EE 36S067	vrac	4026851012135	67	10	0,500 kg	-	1	1	196,00
EE 36S081	vrac	4026851012142	81	11	0,700 kg	-	1	1	210,00
Centreerpin voor ESD 1801 • Tige de centrage pour ESD 1801									
DX 981217		5420000024588	230	-	0,120 kg	-	1	1	36,29



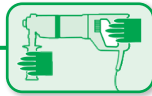

Baksteen, zachte materialen
Brique et matériau tendre



Beton, gewapend beton
Béton et béton armé



DUST PROTECTION SYSTEM
Mineral dust may cause cancer



EE 03E25 ESD 162

	2200W 230V
	1100 min ⁻¹
	82 - 162 mm
	Max ø 202 mm
	22000 / min
	1/2" + 5/4" UNC
	60 mm
	5 m H07BQ-F Kabel / Cable PUR
	compatibel
	6,6 kg

Stofafzuigsysteem
Système d'aspiration



SOFT-IMPACT knop
Bouton SOFT-IMPACT



EE 03E25

**BOORDIAMETER TOT
DIAMÈTRE DE FORAGE JUSQU'À
162 mm*!**

* In licht gewapend beton - Dans le béton armé léger

TOEBEHOREN • ACCESSOIRES

2 x montagesleutels / 1 x koffer
2 x clés de montage / 1 x coffre

Te gebruiken met het boorstatief BST 162H - SPECIAL IMPACT (EE 0963W - zie pagina 22)

A utiliser avec le bâti de forage BST 162H - SPECIAL IMPACT (EE 0963W - voir page 22)

SPECIAL IMPACT MACHINE

Boorkroon
niet inbegrepen
Couronne
non-incluse



EE 03SI26-SET

SET :
ESD 162 + BST 162H



code							min.	€
EE 03E25	koffer/coffre	4026851018564	2200 Watt	11,820 kg	-	1	1	989,00
EE 03SI26-SET		5420000066816	SET: ESD 162 + BST 162H	30,100 kg	-	1	1	1864,00

Geschikt voor / Adapté pour :



Droog boren met hoge werksnelheden in bijzonder harde materialen zoals gewapend beton (met statief), zeer compacte kalkzandsteen en metselwerk.

Forage à sec et à des vitesses de travail élevées dans des matériaux particulièrement durs, par exemple : béton armé (avec trépied), brique silico-calcaire très compacte et maçonnerie.

Perfekte probleemoplossing voor boringen op plaatsen waar nat boren niet mogelijk is en zo waterschade voorkomen wordt. (holle plafonds, enz.)



Parfait solutionneur de problèmes pour les forages où les conditions sur site ne permettent pas le forage à eau. (plafonds creux, etc. et prévient ainsi des dégâts des eaux)



Nieuw ontwikkelde IHT-tandwielen met uiterst precieze tandwielgeometrie - uiterst robuust dankzij

de Impact Hybrid Technology (IHT), die een geoptimaliseerde hoogfrequente slagimpuls in de richting van de boor mogelijk maakt voor een snellere boorvoortgang. Voor optimale resultaten wordt het gebruik van slagboren met SOFT-IMPACT ten zeerste aanbevolen.

Engrenages IHT nouvellement développés avec géométrie de couronne dentée de haute précision - extrêmement robustes grâce à l'Impact Hybrid Technology (IHT), qui permet une impulsion d'impact optimisée à haute fréquence en direction de la couronne de forage pour une progression de forage plus rapide. Pour des résultats optimaux, il est vivement recommandé d'utiliser les couronnes de forage à percussion SOFT-IMPACT.

EE 03SI25-BOX

SET : ESD 162 +
boorkronen/couronnes
CD-DI 835
Ø 82 - 112 - 132 mm



L = 305 mm - 1 1/4"
Ø 82 - 112 - 132 mm

code	icon	barcode	info	scales	box	min.	€
EE 03SI25-BOX	koffer/coffre	5420000066809	Machine +	27,080 kg	-	1 1	1730,00
3 boorkronen/couronnes							

SOFT-IMPACT - Diamant droogboorkroon
SOFT-IMPACT - Couronne diamantée à sec

code	icon	barcode	Ø	#	scales	box	min.	€
			mm					
DX 835032	vrac	5420000069961	32	5	0,800 kg	-	1 1	107,00
DX 835042	vrac	5420000069978	42	5	0,880 kg	-	1 1	107,00
DX 835052	vrac	5420000069985	52	5	1,090 kg	-	1 1	112,00
DX 835062	vrac	5420000069992	62	5	1,300 kg	-	1 1	128,00
DX 835072	vrac	5420000070004	72	6	1,510 kg	-	1 1	138,00
DX 835076	vrac	5420000070127	76	6	1,720 kg	-	1 1	140,00
DX 835082	vrac	5420000070011	82	6	1,720 kg	-	1 1	143,00
DX 835092	vrac	5420000070028	92	6	1,930 kg	-	1 1	152,00
DX 835102	vrac	5420000070035	102	7	2,140 kg	-	1 1	157,00
DX 835112	vrac	5420000070042	112	7	2,350 kg	-	1 1	162,00
DX 835122	vrac	5420000070059	122	8	2,560 kg	-	1 1	180,00
DX 835132	vrac	5420000070066	132	8	2,770 kg	-	1 1	195,00
DX 835142	vrac	5420000070073	142	8	2,980 kg	-	1 1	267,00
DX 835152	vrac	5420000070080	152	8	3,190 kg	-	1 1	289,00
DX 835162	vrac	5420000070097	162	9	3,400 kg	-	1 1	320,00

NEW

1 1/4"
5/4"

CD-DI 835



Gebruik met IHT soft impact boorkroonmachine + statief

Utilisation avec carotteuse et trépied soft impact IHT



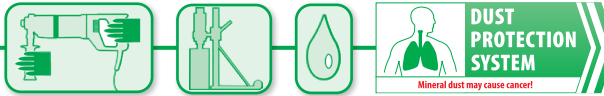

EE 03114 END 1550 P

	1500W 230V
	1800 - 4400 min⁻¹
	6 - 68 mm
	G1/2"i
	53 mm
	3 m H07RN-F
	3,6 kg



INCLUSIEF TOEBEHOREN ACCESSOIRES INCLUS

Snelwisseladapter G $\frac{1}{2}$ " a / G $\frac{1}{2}$ " i
+ adaptateur G $\frac{1}{2}$ " / M12x1,5 a
Adaptateur à changement rapide G $\frac{1}{2}$ " a / G $\frac{1}{2}$ " i
+ adaptateur G $\frac{1}{2}$ " / M12x1,5 a



- Elektronische overbelastingsbeveiliging en temperatuurcontrole, zachte aanloop. Protection électronique de surcharge et contrôle de la température démarrage progressif.
- As in roestvrijstaal. Axe en acier inoxydable.
- Traploze watervoorziening. Réglage en continu de l'arrivée d'eau.
- Quick change systeem. Système de changement rapide.

code							
EE 03114	koffer/coffre	4026851011329	1500 Watt	11,740 kg	-	1 1	596,00

CD - W600 Premium Graniet • Granite



R1/2"

code									
			mm	mm					
DX 920006		5420000021389	6,3	50	○	0,201 kg	-	1 1	62,20
DX 920008		5420000021396	8,3	50	○	0,200 kg	-	1 1	67,70
DX 920010		5420000021402	10	50	○	0,202 kg	-	1 1	74,30
DX 920012		5420000021419	12	120	○	0,219 kg	-	1 1	77,30
DX 920014		5420000021426	14	120	○	0,215 kg	-	1 1	81,30
DX 920016		5420000021433	16	120	○	0,192 kg	-	1 1	87,30
DX 920018		5420000021440	18	120	○	0,206 kg	-	1 1	90,70
DX 920020		5420000021457	20	120	○	0,203 kg	-	1 1	102,30
DX 920025		5420000021464	25	120	○	0,233 kg	-	1 1	112,90
DX 920032		5420000021471	32	120	○	0,280 kg	-	1 1	125,70
DX 920036		5420000021488	36	120	○	0,314 kg	-	1 1	135,40
DX 920042		5420000021495	42	120	○	0,347 kg	-	1 1	142,00
DX 920051		5420000021501	51	120	5	0,554 kg	-	1 1	152,00





DUST PROTECTION SYSTEM
Mineral dust may cause cancer!

PowerLine

EE 0343X
PLD 182.1 NT

	2300W 230V
	1: 520 min ⁻¹ 2: 1200 min ⁻¹ 3: 2500 min ⁻¹
	1: 122 - 202 mm 2: 62 - 122 mm 3: 12 - 62 mm
	1: 82 - 182 mm 2: 42 - 82 mm 3: 12 - 42 mm
	G1/2"i + 5/4" UNC
	60 mm
	5 m H07BQ-F PUR
	7,5 kg



INCLUSIEF TOEBEHOREN
ACCESSOIRES INCLUS

2 Sleutels
2 Clés de montage



EE 0343S
PLE 182

SET :
PLD 182.1 NT
+
BST 182 V/S 60/P



**"DE KRACHTIGE COMBINATIE
VOOR BORINGEN TOT Ø 202 MM"**
**"LA COMBINAISON PUISSANTE
POUR FORAGES JUSQU'AU Ø 202 MM"**

Boorkroon
niet inbegrepen
Couronne
non-incluse

code							min.	€
EE 0343X	koffer/coffre	4026851017802	2300 Watt	13,000 kg	-	1	1	1326,00
EE 0343S		4026851015679	SET: PLD 182.1 NT + BST 182 V/S 60/P	30,500 kg	-	1	1	2055,00
Vacuüm set • Set Vacuüm								
EE 3585F	zak/sac	4026851013323	Voor / Pour BST 182 V/S	0,433 kg	-	1	1	185,00



EE 03E31
ETN 162/3

	2200W 230V
	1: 0 - 510 min ⁻¹ 2: 0 - 1150 min ⁻¹ 3: 0 - 2500 min ⁻¹
	1: 0 - 510 min ⁻¹ 2: 0 - 1150 min ⁻¹ 3: 0 - 2500 min ⁻¹
	1: 122 - 202 mm 2: 62 - 122 mm 3: 12 - 62 mm
	1: 82 - 162 mm 2: 42 - 82 mm 3: 12 - 42 mm
	5/4" UNC + 1/2"
	60 mm
	5 m H07BQ-F PUR
	6,7 kg



INCLUSIEF TOEBEHOREN
ACCESSOIRES INCLUS

2 Sleutels / Aansluiting voor stofzuiger / water
2 Clés de montage / Raccord pour aspirateur / eau



LED indicator
Vervang de koolborstels - Service-LED lampje brandt ongeveer 10 uur voor uitvallen.
Indicateur LED
Remplacer les charbons Service LED s'allume environ 10 heures avant l'arrêt.



- Oliebadtransmissie voor een maximaal rendement en minimum onderhoud.
Lubrification par bain d'huile pour un rendement maximal et un minimum d'entretien.
- Mechanische slipkoppeling.
Embrayage de sécurité mécanique.
- Elektronisch met zachtloop, thermische- en overbelastingsbeveiliging.
Démarrage progressif géré électroniquement, protection contre les surcharges et protection thermique.
- Geïntegreerde PRCD - Veiligheidsschakelaar (aardlekschakelaar).
Interrupteur PRCD intégré (différentiel de sécurité).

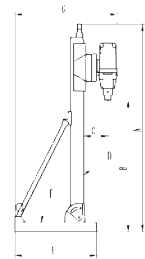

Afmetingen
Dimensions

	EE 03E35-SET
A	1050
B	700
C	130
D Profiel/Profile	46 x 60
E	330
F	250
G	510



code							min.	€
EE 03E31	koffer/coffre	4026851012883	2200 Watt	12,700 kg	32	1	1	1147,00
EE 03E35-SET	koffer/coffre	5420000034105	SET: ETN 162/3 + BST 182 VS	29,700 kg	-	1	1	2038,00
Vacuüm set • Set Vacuüm								
EE 3585F	zak/sac	4026851013323	Voor / Pour BST 182V/S	0,433 kg	-	1	1	185,00

Boorkroon niet inbegrepen
Couronne non-incluse



EE 03G34-SET
SET ETN 162/3

INCLUSIEF TOEBEHOREN
ACCESSOIRES INCLUS

2 Sleutels / Aansluiting voor stofzuiger / water
2 Clés de montage / Raccord pour aspirateur / eau

	2200W 230V
	1: 0-510 min ⁻¹ 2: 0-1150 min ⁻¹ 3: 0-2500 min ⁻¹
	1: 122 - 202 mm 2: 62 - 122 mm 3: 12 - 62 mm
	1: 82 - 162 mm 2: 42 - 82 mm 3: 12 - 42 mm
	5/4" UNC + 1/2"
	60 mm
	5 m H07BQ-F PUR <small>Kabel/ Cable</small>
	6,7 kg



2200W
EXTRA-POWER

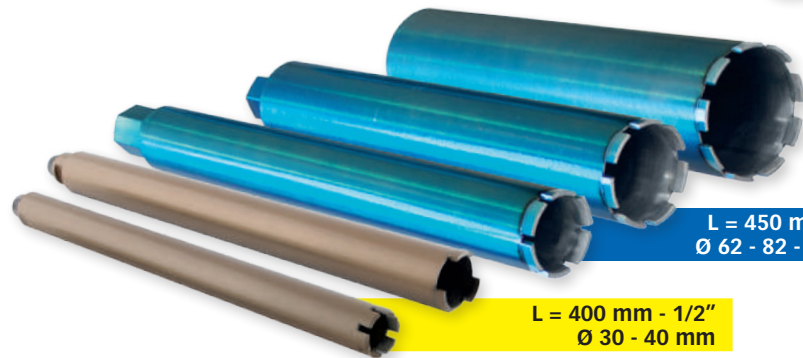

- Oliebadtransmissie voor een maximaal rendement en minimum onderhoud.
Lubrification par bain d'huile pour un rendement maximal et un minimum d'entretien.
- Mechanische slipkoppeling.
Embrayage de sécurité mécanique.
- Elektronisch met zachtloop, thermische- en overbelastingsbeveiliging.
Démarrage progressif géré électroniquement, protection contre les surcharges et protection thermique
- Geïntegreerde PRCD - Veiligheidsschakelaar (aardlekschakelaar)
Interrupteur PRCD intégré (différentiel de sécurité)

code							min.	€
EE 03G34-SET	koffer/coffre	542000061668	Machine + diamant boorkronen couronnes diamantées Ø 112 - 82 - 62 - 40 - 30 mm + Toebehoren / Accessoires	30,840 kg	15	1	1	1815,00



EE 0352H

EBM 250/2 RP

	2500W 230V
	.
	1: 360 min ⁻¹ 2: 850 min ⁻¹
	52 - 252 mm
	5/4" UNC
	5 m H07BQ-F
	10,5 kg

EE 03641

EBM 352/3

	3000W 230V
	.
	1: 230 min ⁻¹ 2: 500 min ⁻¹ 3: 1030 min ⁻¹
	42 - 352 mm
	5/4" UNC
	5 m H07BQ-F
	12,5 kg

Kabel / Cable
PUR



LED indicator
Vervang de koolborstels -
Service-LED lampje brandt
ongeveer 10 uur voor
uitvallen.
Indicateur LED
Remplacer les charbons
Service LED s'allume envi-
ron 10 heures avant l'arrêt.



INCLUSIEF TOEBEHOREN
ACCESSOIRES INCLUS

2 Sleutels
2 Clés de montage



code							min.	€
EE 0352H		4026851011404	2500 Watt	13,080 kg	-	1	1	1138,00
EE 03641		4026851012913	3000 Watt	15,560 kg	-	1	1	1579,00
EE 0B33R		4026851017680	2500 Watt	17,340 kg	-	1	1	1030,00

EE 0B33R

DB 201

	2500W 230V
	675 min ⁻¹
	Ø 80 - 202 mm
	1/2" + 5/4" UNC
	790 mm
	15,5 kg

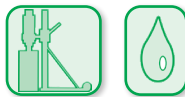

**BOORDIAMETER TOT
DIAMÈTRE DE FORAGE JUSQU'À
202 mm!**



EE 0B33R
Boorkroon
niet inbegrepen
Couronne
non-incluse





PowerLine

EE 0373G PLD 450.2 B

	3300W 230V
	1: 230 min ⁻¹ 2: 525 min ⁻¹ 3: 1025 min ⁻¹
	1: 150 min ⁻¹ 2: 340 min ⁻¹ 3: 700 min ⁻¹
	71 - 452 mm
	5/4" UNC
	5 m H07BQ-F
	15,3 kg

Kabel / Cable
PUR



EE 0373G

"SNELLE SERIEMATIGE BORINGEN"
"MACHINE POUR FORAGES RAPIDES EN SÉRIE"

INCLUSIEF TOEBEHOREN
ACCESSOIRES INCLUS

2 Sleutels
2 Clés de montage



code							min.	€
EE 0373G		4026851018502	3300 Watt	18,720 kg	-	1	1	1976,00
EE 0962M		4026851011848	Voor / Pour PLD 450.2 B	30,500 kg	-	1	1	1350,00

EE 0962M PLB 450

	452 mm
	960 mm (STAAL/ACIER)
	45°
	295 x 195 mm
	27,0 kg



EE 0962M

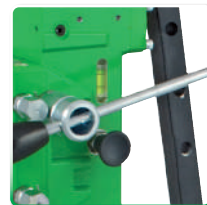



**SPECIAL
IMPACT
MACHINE**

voor / pour
ESD 162

EE 0964P
BST 160/60

EE 0963W
BST 162H

EE 0964X
BST 182 V/S 60/P

EE 09646
BST 182 V/S

90° MAX Ø	160 mm	202 mm	202 mm	202 mm
850 mm (ALU)	850 mm (ALU)	860 mm (ALU)	995 mm (ALU)	995 mm (ALU)
60 mm	60 mm	60 mm	60 mm	
45°	45°	45°	45°	45°
320 x 110 mm	320 x 110 mm	320 x 220 mm	330 x 250 mm	330 x 250 mm
	-	-	V	V
10,0 kg	10,0 kg	10,5 kg	14,0 kg	14,0 kg

code							min.	€
EE 0964P		4026851015167	BST 160/60	12,300 kg	10	1	1	496,00
EE 0963W		4026851018793	BST 162H	12,300 kg	15	1	1	897,00
EE 0964X		4026851015730	BST 182 V/S 60/P	17,500 kg	6	1	1	924,00
EE 09646		4026851015440	BST 182 V/S	17,000 kg	6	1	1	946,00
Spanhalsadapter voor BST 182 V/S • Adaptateur de serrage pour BST 182 V/S								
EE 35829	vrac	4026851014986	Ø 60 mm	1,500 kg	-	1	1	161,00



EE 35829



EE 09631
BST 250



EE 09647
BST 352 V

3 handgrieps
3 poignées



EE 09655
EBW 1300



	252 mm
	995 mm (ALU)
	60 mm
	45°
	430 x 330 mm
	-
	15,5 kg

	352 mm
	995 mm (ALU)
	60 mm
	45°
	400 x 310 mm
	V
	22,5 kg

	-
	250 - 1300 mm
	60 mm
	-
	-
	-
	24,5 kg



code							min.	€
EE 09631		4026851004826	BST 250	21,500 kg	-	1	1	898,00
EE 09647		4026851012975	BST 352 V	26,500 kg	6	1	1	1156,00
EE 09655		4026851018922	EBW 1300	27,360 kg	-	1	1	1226,00

Aanpassingsring voor BST • Bague de réglage pour BST

EE 35820	vrac	4026851007230	60 x 53 mm	0,048 kg	-	1	1	15,50
EE 35821	vrac	4026851007247	60 x 43 mm	0,104 kg	-	1	1	15,30

Vacuüm set • Set Vacuüm

EE 3585F	zak/sac	4026851013323	Voor / Pour BST 182V/S	0,433 kg	-	1	1	185,00
EE 3585G	zak/sac	4026851013330	Voor / Pour BST 352 V	0,380 kg	-	1	1	198,00

NEW

EE 096U1

USD 182

90° MAX Ø	182 mm
	1160 - 3018 mm
	60 mm
	180°
	302 x 219 mm
	39,9 kg

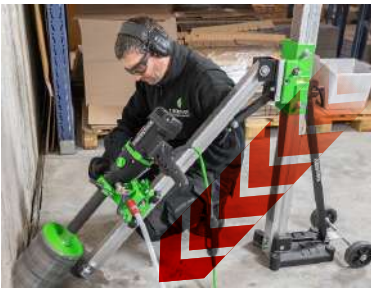

TELESCOPISCH BOORSTATIEF BÂTI DE FORAGE TÉLESCOPIQUE

- De boorunit kan met behulp van een telescopisch statiefsysteem tussen de vloer en het plafond worden vastgezet
La colonne de forage peut être fixée entre le sol et le plafond à l'aide d'un système de trépied télescopique
- Geen montageschade aan muur, vloer of plafond zoals bij "conventionele" boorstatieven, snel en zonder ankers
Aucun dommage de montage au mur, au sol ou au plafond comme avec les supports de forage « classiques », rapidement et sans ancrages
- Boren in vloer, wand en plafond mogelijk, stabiel, massief plafond vereist
Perçage possible dans le sol, le mur et le plafond, plafond stable et solide requis
- Bij onstabiele plafonds kan de USD 182 ook met ankers worden gemonteerd
Pour les plafonds instables, l'USD 182 peut également être monté avec des ancrages
- Flexibele, traploze aanpassing van de boorhoogte door zwenkelvoeding (van 1160 tot 3018 mm)
Réglage flexible et continu de la hauteur de perçage grâce à l'avance par manivelle (de 1160 à 3018 mm)

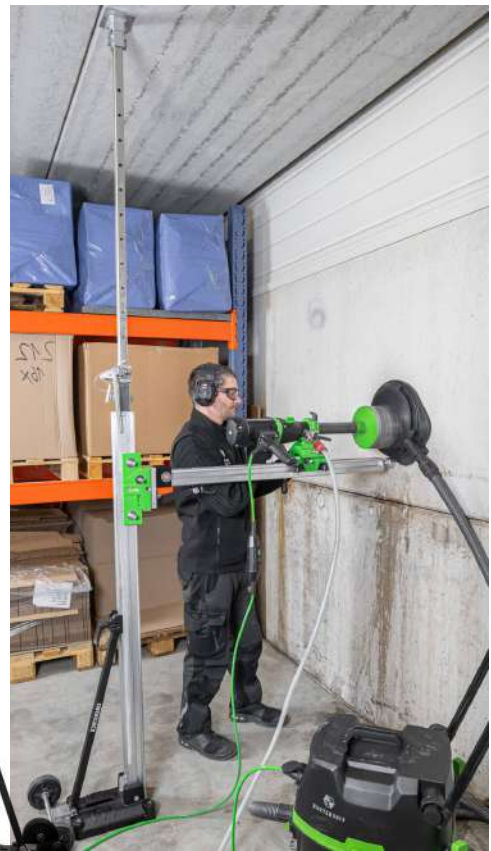

code					min.	€
EE 096U1	4026851019639	USD 182	43,400 kg	-	1	2680,00*

*Prijs voor tel. boorstatief excl. boormotor & boorkroon
*Prix pour bâti de forage télescopique hors carotteuse et couronne



NEW

EE 3586P

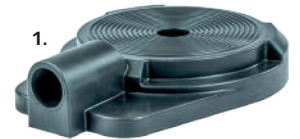

Toebehoren voor diamantboormachines
Accessoires pour machines de forage diamanté

code							min.	€
1. Universele Water-/stofopvangring • Anneau collecteur d'eau/poussière universel								
EE 35876	vrac	4026851018939	UAR 162G	max. Ø 162 mm	0,400 kg	-	1	1 71,00
EE 3586P	vrac	4026851019462	UAR 252G	max. Ø 252 mm	0,860 kg	-	1	1 87,75
2. Telescopisch snelspanzuil • Support télescopique, blocage rapide								
EE 35730	vrac	4026851003980		1,7 m - 3,0 m	8,950 kg	-	1	1 446,00
3. Vacuümpomp • Pompe à vide • VP (Darm niet inbegrepen / Tuyau non inclus)								
EE 09204	vrac	4026851007254	VP 04	DBE 250 - 352	12,050 kg	-	1	1 1438,00
4. Vacuümslang incl. 2 koppelingen • Flexible de la pompe à vide, 2 raccord incl.								
EE 35855	vrac	4026851003898		L = 3 m	1,014 kg	-	1	1 38,50
5. Vacuümplaat • système de fixation sous vide								
EE 35851	vrac	4026851003881		BST 103 - 152	3,559 kg	-	1	1 227,00
6. Bevestigingsset beton • Set de fixation pour le béton								
EE 35720	vrac	4026851004864		M12 - Ø 15 mm + 10 inslagankers / chevilles à frappe	1,258 kg	-	1	1 45,50
7. Bevestigingsset voor metselwerk • Set de fixation pour maçonnerie								
EE 35724	vrac	4026851005175		M12 - Ø 20 mm	0,714 kg	-	1	1 32,00
8. Waterdrukvat • Réservoir d'eau sous pression								
EE 35812	vrac	4026851010292		10 l - 6 bar	6,500 kg	-	1	1 263,00
9. Centreerboor voor boorkroon • Mèche de centrage pour couronne								
EE 36391	vrac	4026851005472		max = 450 mm Voor / Pour 5/4"	1,096 kg	-	1	1 79,00
10. Spanhalsadapter voor BST 182 V/S • Adaptateur de serrage pour BST 182 V/S								
EE 35829	vrac	4026851014986		Ø 60 mm	1,500 kg	-	1	1 161,00
11. Debiet indicator voor kroonboormachines waterstroomb • Indicateur de débit pour carottes - débit d'eau								
EE 35819	vrac	4026851018229		Ø 60 mm	0,182 kg	-	1	1 83,10

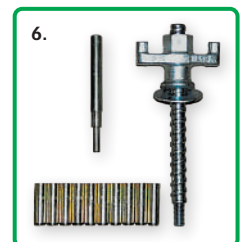
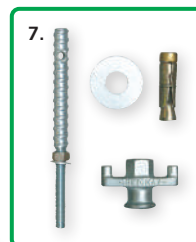



EE 05710 WPN 180

	1200W 230V
	Max. 180 mm 100 - 180 mm
	1.500 min ⁻¹ 2.800 min ⁻¹
	M14
	5 m H07RN-F
	4,4 kg



code								min.	€
EE 05710		4026851003515	1200 Watt	4,740 kg	-	1	1	1	472,00
Velcro - steunschijf M14 voor "NAT & DROOG" gebruik • Plaque velcro - M 14 pour utilisation à "EAU & SEC"									
EE 37300	zakje/sachet	5021526113406	∅ 100 mm	0,070 kg	-	1	1	1	14,80
EE 37302	zakje/sachet	4026851004413	∅ 125 mm	0,118 kg	-	1	1	1	16,60



EE 37300
EE 37302



Rubber steunschijf "Flexibel" voor nat & droog gebruik

Support "Flexible" pour patins de polissage pour utilisation à eau et à sec



code								min.	€
DX 745100		5420000034617	M14	100 mm	0,101 kg	-	1	1	17,97
DX 745125		5420000068605	M14	125 mm	0,170 kg	-	1	1	18,00

Set Diamantpads - "3-STEP" systeem droog en nat polijsten

Patins de polissage en set - système "3-STEP" polissage à eau et à sec



code								min.	€
DX 750500		5420000034624	H1 → H3	100 mm	0,325 kg	-	1	1	108,30

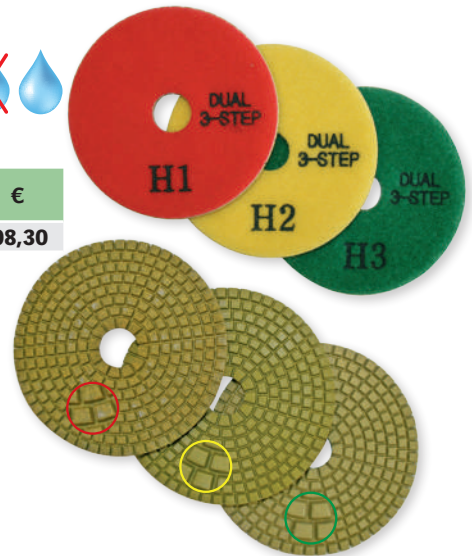

DX 751908

Set Diamantpads - 8-delige droog polijsten

Patins de polissage en set - 8 pièces polissage à sec

code								min.	€
DX 751908		5420000068612	50 ▶ 3000	125 mm	0,342 kg	-	1	1	115,00



EE 0650L
EPG 400 WP

	500W 230V
	370 mm Ø MM
	0 - 60 min⁻¹
	5 m H07RN-F
	3,8 kg



EE 0650L

- Multifunctioneel :
Schuren - gladmaken - krabben - schaven
Multifonctionnelle :
Poncer - lisser - gratter - raboter

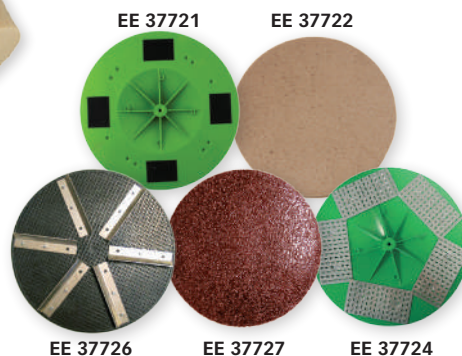

INCLUSIEF TOEBEHOREN
ACCESSOIRES INCLUS

1 x EE 37721
1 x EE 37722

EE 37726

EE 37727

EE 37724



code							min.	€
EE 0650L	koffer/coffre	4026851012333	500 Watt	10,480 kg	-	1	1	573,00
Basis steunschijf • Support de base								
EE 37721	vrac	4026851010957	Ø 370 mm	0,733 kg	-	1	1	27,50
Synthetische spons • Éponge synthétique								
EE 37722	vrac	4026851010964	Ø 400 mm	0,377 kg	-	1	1	21,30
Schaafbord • Plateau à raboter								
EE 37726	vrac	4026851011558	Ø 380 mm	1,160 kg	-	1	1	72,80
Schuurschijf • Disque abrasif								
EE 37727	vrac	4026851011565	Ø 370 mm	0,388 kg	-	1	1	22,70
Krabbord schijf • Plateau à gratter								
EE 37724	vrac	4026851011480	Ø 370 mm	1,150 kg	-	1	1	78,80

EE 065A3
EPG 300 A

	300 mm Ø MM
	0 - 180 min⁻¹
	18 V 5,2 Ah Li-Ion
	4,270 kg

NEW



EE 065A3



INCLUSIEF TOEBEHOREN
ACCESSOIRES INCLUS

1 x EE 3772C / 1 x EE 3772D
2 x EE 37731 (batterij / batterie)
1 x EE 37734 (Lader / chargeur)

Vrijheid van beweging | 30 minuten autonomie | Ideaal voor snel werken op grote oppervlakken
Liberté de mouvement | 30 min d'autonomie | Parfait pour travailler rapidement sur de larges surfaces.

code							min.	€
EE 065A3	koffer/coffre	4026851019394	18 V, 5,2 Ah Li-Ion	5,900 kg	-	1	1	998,00
Basis steunschijf • Support de base								
EE 3772C	vrac	4026851019646	Ø 300 mm	0,520 kg	-	1	1	24,75
Synthetische spons • Éponge synthétique								
EE 3772D	vrac	4026851019653	Ø 320 mm	0,340 kg	-	1	1	20,25
Rubberen spons • Caoutchouc spongieux								
EE 3772E	vrac	4026851019660	Ø 300 mm	0,500 kg	-	1	1	59,00
Schuurbord • Taloché								
EE 37728	vrac	4026851011701	Ø 380 mm	0,680 kg	-	1	1	21,80



EE 3772E

EE 37728



EE 0630F

EBS 120.1

EE 0633L

EBS 1802 SH

	1400W 230V	1800W 230V
	125 mm incl.	125 mm incl.
	8.000 min ⁻¹	10.000 min ⁻¹
	22,2 mm	22,2 mm
	5 m H07RN-F	5 m H07RN-F
	compatibel	compatibel
	3,5 kg	5,9 kg



EE 0630F



INCLUSIEF TOEBEHOREN
ACCESSOIRES INCLUS

Koffer + 1 x Diamantslijpkop (Beton - Ø 125 mm)
Coffre + 1 x Disque à poncer diamanté (Béton - Ø 125 mm)

EE 0633L



INCLUSIEF TOEBEHOREN
ACCESSOIRES INCLUS

1 x Schijf PKD Ø 125 mm
1 x Disque PCD Ø 125 mm



code							min.	€
EE 0630F	koffer/coffre	4026851016058	1400 Watt	7,100 kg	-	1	1	528,00
EE 0633L	koffer/coffre	4026851010087	1800 Watt	11,540 kg	-	1	1	925,00

- Multifunctioneel, verschillende materialen : beton, lijmresten, pleister, keramische tegels.
Multifonctionnel, différents matériaux : béton, résidus de colle, crépis, carrelages en céramique
- PKD diamantkomschijf met monobloc diamanten voor het verwijderen van dunne coatings, epoxylagen zonder dicht te slippen of te smeren.
PCD meule au diamant avec diamant monobloc enlève parfaitement les revêtements minces sans s'encrasser ni laisser de souillure.
- 3 x hoger freesrendement in vergelijking met traditionele schijven.
3 x plus de rendement de fraisage par rapport aux disques conventionnels.

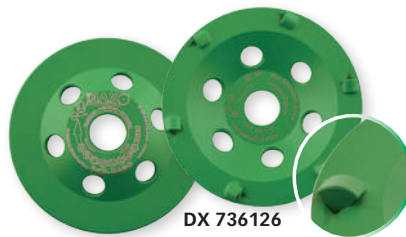

DX 736126



EE 37115

**ANDERE SCHIJVEN
OP BLZ. 72 - 73
AUTRES DISQUES
P. 72 - 73**

code							min.	€
PKD Diamant komschijf - Ø 125 mm • Meule diamantée PCD - Ø 125 mm								
DX 736126		5420000059306	UNIVERSAL	0,480 kg	-	1	1	183,00
EE 37115		4026851010193	Voor / Pour EBS 1802 SH	0,466 kg	-	1	1	276,00

- Voorkomt dichtslippen van de segmenten.
Pas d'engluement des segments.

PCD : Poly Cristal Diamant



EE 06324
EE 06325

TOEBEHOREN • ACCESSOIRES

1 x Schijf Ø 125 mm inbegrepen
1 x Disque Ø 125 mm inclus



EE 0633J

TOEBEHOREN • ACCESSOIRES

1 x Schijf Ø 125 mm inbegrepen
1 x Disque Ø 125 mm inclus



EE 0633H

TOEBEHOREN • ACCESSOIRES

1 x Schijf Ø 180 mm inbegrepen
1 x Disque Ø 180 mm inclus

	EE 06324 EBS 125.4 O	EE 06325 EBS 125.4 RO	EE 0633J EBS 1802	EE 0633H EBS 180 H
	1500W 230V	1500W 230V	1800W 230V	2500W 230V
	125 mm incl.	125 mm incl.	125 mm incl.	180 mm incl.
	10.000 min ⁻¹	6.000 min ⁻¹ 10.000 min ⁻¹	10.000 min ⁻¹	8.500 min ⁻¹
	22,2 mm	22,2 mm	22,2 mm	22,2 mm
	5 m H07RN-F	5 m H07RN-F	5 m H07RN-F	5 m H07RN-F
	compatibel	compatibel	compatibel	compatibel
	4,7 kg	4,7 kg	5,9 kg	8,4 kg

- Anti-vibratie systeem, geringe trillingen, hogere werkveiligheid.
Dispositif antivibratoire pour une meilleure protection des ouvriers.
- Verticale positionering van de motor in een stofarme zone resulteert in een langere levensduur.
Positionnement vertical du moteur dans une zone protégée de la poussière correspond à une longue durée de vie.
- Krachtige motor, grote energiereserve.
Moteur puissant, grande réserve d'énergie.
- Optimale rand- en hoektoegankelijkheid dankzij demonteerbare zijkant.
Ponçage jusqu'au bord et dans les coins grâce à la partie détachable.



EE 37218



code							min.	€
EE 06324	koffer/coffre	4026851003676	1500 Watt	10,020 kg	-	1	1	642,00
EE 06325	koffer/coffre	4026851003683	1500 Watt	10,060 kg	-	1	1	595,00
EE 0633J	koffer/coffre	4026851010056	1800 Watt	11,360 kg	-	1	1	712,00
EE 0633H	koffer/coffre	4026851012982	2500 Watt	15,020 kg	-	1	1	1091,00
Vloergeleidingsframe • Cadre de guidage au sol								
EE 37218	koffer/coffre	4026851018915	EBS 125 - EBS 1802 - 180H	8,500 kg	-	1	1	509,00



In hoogte verstelbaar voor een goed slijpresultaat.
Réglable en hauteur pour un bon résultat de ponçage.



CARACTÉRISTIQUES

KENMERKEN

EE 0634H
EBS 180 F

EE 06346
EBS 235.1

	2500W 230V	2200W 230V
	180 mm incl.	235 mm incl.
	8.500 min⁻¹	1.380 min⁻¹
	22,2 mm	M20 Special
	5 m H07RN-F	5 m H07RN-F
	compatibel	compatibel
	10,5 kg	38 kg



EE 06346

Exclusief slijpschijf
Disque à poncer non-inclus

INCLUSIEF TOEBEHOREN
ACCESSOIRES INCLUS

1 x Diamantslijpkop (Beton Ø 180 mm)
en montagegereedschap

Disques à poncer diamanté (Béton Ø 180 mm)
et des outils de montage



Speciaal voor vloeroppervlakken met vloergeleidingssysteem.
Special pour les surfaces de sols avec système de guidage.



code							min.	€
EE 0634H		4026851015839	2500 Watt	14,500 kg	-	1	1	1231,00
EE 06346		4026851011800	2200 Watt	45,000 kg	-	1	1	1670,00
Diamant slijpschijf voor beton - EBS 235.1 • Meule diamantée pour béton - EBS 235.1								
EE 37117		4026851011633	Ø 235 mm	1,520 kg	-	1	1	308,00
Diamant slijpschijf voor chape - EBS 235.1 • Meule diamantée pour chape - EBS 235.1								
EE 37135		4026851019110	Ø 235 mm	3,020 kg	-	1	1	350,00
Diamant slijpschijf PCD - EBS 235.1 • Meule diamantée PCD - EBS 235.1								
EE 37136		4026851019127	Ø 235 mm	2,780 kg	-	1	1	587,00





EE 06231
ELS 125 D

	1200W 230V
	125 mm incl.
	8.000 min⁻¹
	22,2 mm
	5 m H07RN-F
	compatibel
	5,3 kg



TOEBEHOREN INBEGREPEN
ACCESSOIRES INCLUS

- Draagzak + Diamant schuurschijf universeel + Montagesleutel
- Sac de transport + Meule diamantée universel + Clé de montage

ZW EE76231598

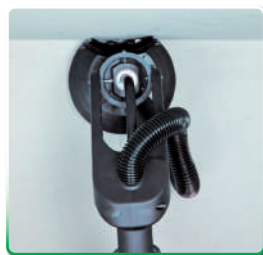

ELS 125 D is bestemd voor het droog slijpen en gladden van bekistingsnaden, bramen en onregelmatigheden op beton. Het elektrische gereedschap mag uitsluitend in combinatie met een diamantkomschijf en een zuiger van de stofklasse M (Ref. EE 09919) gebruikt worden. Gebruik alleen slijpwielen die door de fabrikant worden aanbevolen. Deze zijn licht van gewicht en hebben een hoge concentriciteit. Het gebruik van andere slijpwielen kan een overbelasting van de machine, schade aan de lagers en gevaar voor de gebruiker veroorzaken.

ELS 125 D est destiné au meulage à sec et au lissage des coupures de coffrage, des bavures et des irrégularités sur le béton. L'outil électroportatif doit être utilisé exclusivement avec une meule assiette diamantée et un aspirateur de classe M (Réf. EE 09919). N'utilisez que les disques recommandés par le fabricant ! Des disques trop lourds ou non équilibrés peuvent conduire à la surcharge et à la détérioration de la machine.

code							min.	€
EE 06231		4026851016423	1200 Watt	10,660 kg	-	1	1	1034,00
Extra handgreep • Poignée auxiliaire								
EE 37659		4026851015242	PVC	0,600 kg	-	1	1	52,50
Diamant schuurschijf vlakschuren van beton • Meule diamantée pour meulage de surface du béton								
EE 37126		4026851016492	Ø 125 mm	0,560 kg	-	1	1	102,00
Diamant schuurschijf voor beton-lijm-plaaster • Meule diamantée pour béton-adhésif-plâtre								
EE 37128		4026851016515	Ø 125 mm	0,460 kg	-	1	1	171,00

EE 37659



EE 37126

EE 37128



EE 0651L EPF 1503

	1500W 230V
	140 mm incl.
	4000 min ⁻¹
	M14
	5 m H07RN-F
	compatibel
	3,9 kg



INCLUSIEF TOEBEHOREN
ACCESSOIRES INCLUS

1 x Kruis / 16 sterren
1 x Tourniquet / 16 étoiles

code							min.	€
EE 0651L	koffer/coffre	4026851009531	1500 Watt	10,200 kg	-	1	1	663,00
Kruis compleet met 16 gekartelde freeswielen (hardmetaal) Tourniquet avec 16 étoiles de fraisage coudées (carbure)								
EE 37428	vrac	4026851009586	Voor / Pour EPF 1503	1,050 kg	-	1	1	191,00



Diepteregeling
Réglage de profondeur
0,1 mm → 1,0 mm

EE 06535 EOF 100.1

	1400W 230V
	100 mm
	10.000 min ⁻¹
	22,2 mm
	3 m H05RN-F
	compatibel
	3,4 kg



INCLUSIEF TOEBEHOREN
ACCESSOIRES INCLUS

Montagesleutel
Clé de montage

Betere afzuiging
Aspiration améliorée

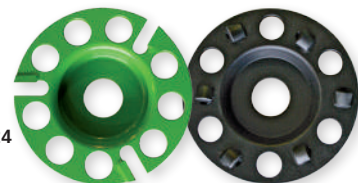

code							min.	€
EE 06535	koffer/coffre	4026851017611	1400 Watt	7,060 kg	-	1	1	297,00
Hardmetalen schuurschijf 100 mm - ondergronden in hout Disque abrasif carbide 100 mm - surfaces en bois								
EE 37124	vrac	4026851015327	Voor / Pour EOF 100.1	0,350 kg	-	1	1	125,00
Diamant schuurschijf PKD 100 mm - minerale ondergronden Disque abrasif PCD 100 mm - surfaces minérales								
EE 37125	vrac	4026851015495	Voor / Pour EOF 100.1	0,350 kg	-	1	1	141,00



EE 0620N
ELS 225.1

	590W 230V
	225 mm incl.
	1.050 - 1.600 min ⁻¹
	M14
	5 m H07RN-F
	compatibel
	4,9 kg



Met afzuiging
Avec aspiration
VACU-GLIDE

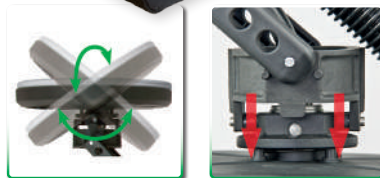

INCLUSIEF TOEBEHOREN
ACCESSOIRES INCLUS

Draagzak + verlengstuk + schuimring + borsteling +
schuurschijf (1 x K80 - K100 - K120)
Sac de transport + rallonge + anneau en mousse +
brosse + disque de ponçage (1 x K80 - K100 - K120)

Aanzuiging van lichtere werking dankzij het VacuGlide-System
Léger effet d'aspiration grâce au système VacuGlide

Verbeterde aandrijving = minder trillingen
Amélioration de la transmission = moins de vibrations

Verbeterde flexibele aandrijving
Amélioration de la transmission du flexible

Verbeterde afschermingskop met 2 uitvoeringen : rubber en borstel
Protection améliorée de la coiffe avec 2 applications : caoutchouc et brosse

code							min.	€
EE 0620N		4026851015303	590 Watt	9,840 kg	12	1	1	755,00
Extra handgreep • Poignée auxiliaire								
EE 37659		4026851015242	PVC	0,600 kg	-	1	1	52,50
Basisplaat voor ELS 225.1 & ETS 225 • Plaque pour ELS 225.1 & ETS 225								
EE 37631	vrac	4026851008947	Ø 225 mm	0,080 kg	-	1	1	19,70
Schuimrubberen steunzool met 6 perforaties • Support en mousse avec 6 perforations								
EE 37632	vrac	4026851008954	Ø 225 mm	0,044 kg	-	1	1	20,30
Schuimring VacuGlide • Anneau en mousse Vacu-Glide								
EE 3722C	vrac	4026851015310	-	0,200 kg	-	1	1	21,30
Aandrijfflexibel voor ELS 225.1 / wisselstuk • Flexible d'entraînement pour ELS 225.1 / pièce de rechange								
ZW EE7620L598	vrac	-	-	0,422 kg	-	1	1	98,70

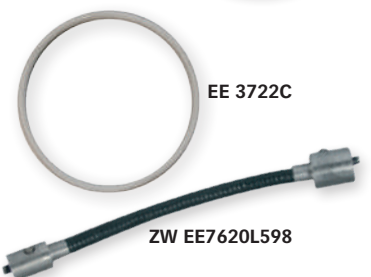



EE 06203
ETS 225

	700W 230V
	225 mm
	0 - 1.450 min⁻¹
	5 m H07RN-F
	compatibel
	2,9 kg



INCLUSIEF TOEBEHOREN • ACCESSOIRES INCLUS

velcro schuurpapier P60 - P80 - P100 - P220 + sleutel
Papier à poncer velcro P60 - P80 - P100 - P220 + clé

EE 37631

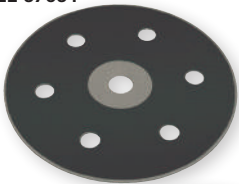

EE 37632



code							min.	€
EE 06203	koffer/coffre	4026851005977	700 Watt	5,840 kg	-	1	1	356,00

Toebehoren voor schuurmachine • Accessoires pour ponceuse

code							min.	€
Basisplaat voor ELS 225.1 & ETS 225 • Plaque pour ELS 225.1 & ETS 225								
EE 37631	vrac	4026851008947	Ø 225 mm	0,080 kg	-	1	1	19,70
Schuimrubberen steunzool met 6 perforaties • Support en mousse avec 6 perforations								
EE 37632	vrac	4026851008954	Ø 225 mm	0,044 kg	-	1	1	20,30

geschikt voor alle bestaande machines
convient à toutes les machines existantes

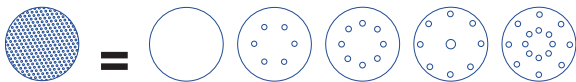

Velcro schuurpapier "Multi-Hole"
Papier à poncer "Multi-Hole"

code				Ø dia.				min.	€
					mm	Prijs per 6 st. • Prix par 6 pcs			
DX 075040		542000063709	P40	225	0,200 kg	-	20	1	13,46
DX 075060		542000063716	P60	225	0,200 kg	-	20	1	13,46
DX 075080		542000063723	P80	225	0,200 kg	-	20	1	13,46
DX 075100		542000063730	P100	225	0,200 kg	-	20	1	13,46
DX 075120		542000063747	P120	225	0,200 kg	-	20	1	13,46
DX 075150		542000063754	P150	225	0,200 kg	-	20	1	13,46
DX 075180		542000063761	P180	225	0,200 kg	-	20	1	13,46
DX 075220		542000063778	P220	225	0,200 kg	-	20	1	13,46

per par 6 stuks
pièces



- Voor alle merken
- Hogere stofafzuiging
- Toutes marques
- Aspiration supérieure

1800W
EXTRA POWER

VOOR / POUR
YTONG & POROTON



EE 06644
EDB 480.1

	1800W 230V
	480 mm
	3.100 / min
	5 m H07RN-F
	6,1 kg

1 mes voor alle toepassingen
1 lame pour toutes les applications



Voor het snijden van Poroton, geperforeerde baksteen, cellenbeton, hout.
Pour couper Poroton, brique perforée, béton cellulaire, bois.

Ergonomische handgreep kan gemonteerd worden op beide kanten van de machine.
Poignée ergonomique pouvant être monté sur les 2 cotés de la machine.

Robuuste bladstructuur voor een nauwkeurige snede.
Structure de la lame robuste pour une découpe précise



Ergonomische handgreep kan gemonteerd worden op beide kanten van de machine.

Poignée ergonomique pouvant être monté sur les 2 cotés de la machine.

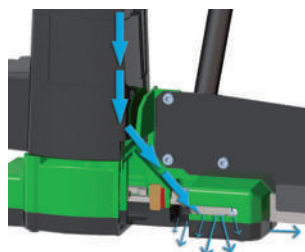

Motorbescherming tegen stof.
Voor gebruikers met speciale behoeften.
Geïntegreerde blaasfunctie.

Protection du moteur contre la poussière.
Pour les utilisateurs ayant des besoins spéciaux.
Fonction soufflerie intégrée.

code							min.	€
EE 06644		4026851015853	1800 Watt	8,920 kg	-	1	1	722,00
Vervang zaagblad voor EDB 480.1 • Lame de rechange pour EDB 480.1								
EE 37452		4026851014672	480 mm	0,200 kg	-	1	1	139,00



EE 0660P EDS 181

	2300W 230V
	7500 min ⁻¹
	4300 min ⁻¹
	58 mm (Ø 180 mm) 63 mm (Ø 200 mm)
	incl. 180 x 22,2 mm (max. 200 mm)
	5 m H07RN-F
	compatibel
	7,7 kg



EE 0660P



INCLUSIEF TOEBEHOREN • ACCESSOIRES INCLUS

- 1 x Diamantschijf beton/natuursteen (Ø180 mm)
Aansluiting voor stofzuiger / water
- 1 x Disque diamanté béton/pierre naturelle (Ø180 mm)
Raccord pour aspirateur / eau

- Ideaal voor vensterbanken, platen, terazzo, gevelstenen, saneren van vloervoegen.
Idéal pour tablettes de fenêtres, rénovation des joints de sols, dalles de façade, dalles en terazzo, plans de travail.
- Traploze verstelling van de zaagdiepte zonder gereedschap.
Réglage en continu de la profondeur de coupe sans outil.
- Asvergrendeling voor makkelijk en snel verwisselen van het zaagblad.
Blocage de l'arbre pour un changement facile et rapide du disque.
- Kantgeleider / Guide latéral

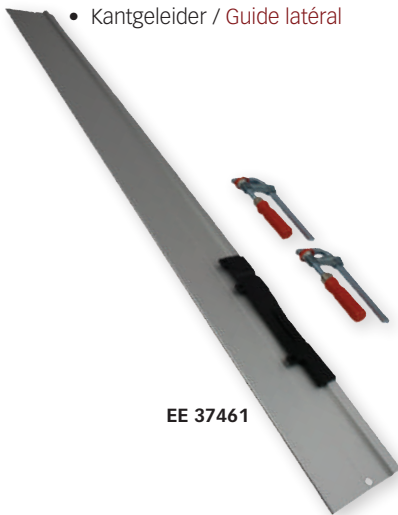

EE 37461



code						min.	€
EE 0660P	koffer/coffre 4026851013552	2300 Watt	17,820 kg	-	1	1	1006,00

TOEBEHOREN VOOR EDS 181 OP BLZ 37 • ACCESSOIRES POUR EDS 181 P. 37



EE 0660V
EDS 125

	1250W 230V
	Max. 125 x 22,2 mm
	12.000 min⁻¹
	36 mm
	5 m H05VV-F
	compatibel met toebehoren avec accessoires
	2,9 kg



INCLUSIEF TOEBEHOREN • ACCESSOIRES INCLUS

- 1 x Diamantschijf beton/natuursteen (Ø125 mm)
- Aansluiting voor stofzuiger / water + koffer
- 1 x Disque diamanté béton/pierre naturelle (Ø125 mm)
- Raccord pour aspirateur / eau + coffre

- Ideaal voor vensterbanken, platen, terazzo, gevelstenen, saneren van vloervoegen.
Idéal pour tablettes de fenêtres, rénovation des joints de sols, dalles de façade, dalles en terazzo, plans de travail.
- Traploze verstelling van de zaagdiepte zonder gereedschap.
Réglage en continu de la profondeur de coupe sans outil.
- Rolgeleidingswagen ter bescherming van het werkoppervlak.
Chariot avec rouleau de guidage pour la protection du matériau à couper.

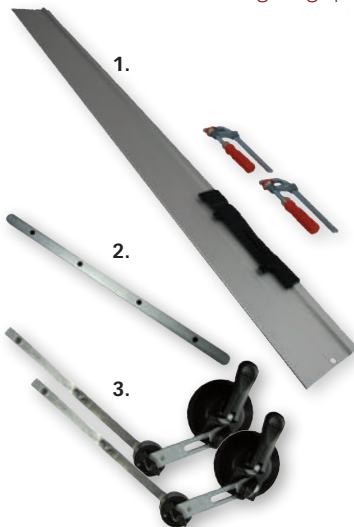

code							min.	€
EE 0660V	koffer/coffre	4026851013835	1250 Watt	7,340 kg	20	1	1	286,00
Geleidingsrail voor EDS 125 - EDS 181 • Rail de guidage pour EDS 125 - EDS 181								
1. EE 37461		4026851012272	750 mm	1,200 kg	-	1	1	106,00
EE 37462		4026851012289	1500 mm	2,390 kg	-	1	1	142,00
Verbinding voor geleidingsrail / EDS 125 - EDS 181 • Raccord pour rail de guidage / EDS 125 - EDS 181								
2. EE 37463		4026851012821	-	0,120 kg	-	1	1	37,90
Zuignap voor geleidingsrail / EDS 125 - EDS 181 • Ventouse pour rail de guidage / EDS 125 - EDS 181								
3. EE 37464		4026851013361	per 2 st - par 2 pcs	1,050 kg	-	1	1	199,00

TOEBEHOREN VOOR EDS 125 & EDS 181 • ACCESSOIRES POUR EDS 125 & EDS 181

Snijtafel voor EDS 125 • Table de coupe pour EDS 125

code							min.	€
EE 37466		4026851014382	ETT 1200 - 1200 mm	18,000 kg	-	1	1	522,00
Verlengstuk voor snijtafel ETT • Rallonge pour table de coupe ETT								
EE 09803		4026851014412	167 x 485 mm	2,132 kg	-	1	1	104,00

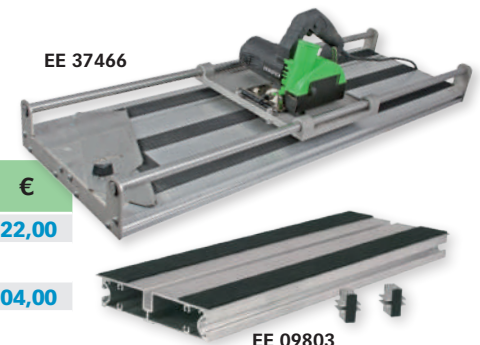



**PROMO
PACK**

**2x
POWER-N
GRATIS
GRATUIT**

**SOFT
START**

EE AP100
EST 350.2

	2400W 230V
	3900 min ⁻¹
	250 mm
	120 mm
	2 x incl. 350 x 25,4 mm
	2,2 m H07RN-F
	compatibel
	19,0 kg



INCLUSIEF TOEBEHOREN • ACCESSOIRES INCLUS

2 x Diamantschijf Prodiaxo Power-N Ø350 mm + montagesleutels
2 x Disque diamanté Prodiaxo Power-N Ø350 mm + Clés de montage



- Stofvrij werken.
Travailler sans poussière.
- Werkstuklem met snelspanfunctie.
Étau à serrage rapide.
- Compact en licht voor comfortabel transport.
Conception compacte et légère pour un transport confortable.



EE 37473

code						min.	€
------	--	--	--	--	--	------	---

Met aanloopstroombegrenzing • Avec limiteur de courant

EE AP100		542000063044	2400 Watt	24,500 kg	12	1	1	679,00
----------	--	--------------	-----------	-----------	----	---	---	---------------

Vouwtafel voor EST 350.2 en HST 350.3
Table pliante pour EST 350.2 et HST 350.3

code						min.	€
------	--	--	--	--	--	------	---

EE 37473		4026851012586	mm 400 x 620	10,400 kg	-	1	1	189,00
----------	--	---------------	-----------------	-----------	---	---	---	---------------



NEW

EE 0663B
HST 350.3

	2300W 230V
	3900 min⁻¹
	230 mm
	120 mm
	1 x incl. 350 x 25,4 mm
	2,2 m H07RN-F
	compatibel
	19,0 kg



Blokkerings-
systeem.
Système de
blocage.

Incl. 1 schijf gratis
1 disque gratuit incl.

TOEBEHOREN • ACCESSOIRES

- Montagesleutels /**
1 x Diamantschijf (Laser Turbo) Ø350 mm
Clés de montage /
1 x Disque diamanté (Laser Turbo) Ø350 mm

- Ergonomische schakelhendel.
Poignée de commutation ergonomique.
- Met rubberen voetjes.
Avec pieds en caoutchouc.
- Werkstuklem met snelspanfunctie.
Étau à serrage rapide.
- Compact en licht voor comfortabel transport
Conception compacte et légère pour un transport confortable

	80 mm	100 mm	120 mm
	230 mm	210 mm	150 mm



code							min.	€
EE 0663B		4026851020512	2300 Watt	21,000 kg	-	1	1	425,00



▲ Stofvrij werken door middel van de aansluiting voor stofzuiger.
Travailler sans poussière grâce à son raccord pour aspirateur.



▲ Met extra handvat voor een comfortabel transport.
Avec poignée supplémentaire pour un transport confortable.

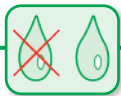

EE 0682A
ETR 400.1 P

NEW
EE 0682E
ETR 400.2 P

	2850W 230V	2850W 230V
	1 x incl. 400 x 25,4 mm	1 x incl. 400 x 25,4 mm
	1950 min ⁻¹	1950 min ⁻¹
	152 mm	152 mm
	5 m H07RN-F	5 m H07RN-F
	compatibel	-
	13,4 kg	11,4 kg



EE 0682A



INCLUSIEF TOEBEHOREN • ACCESSOIRES INCLUS

Aansluiting voor stofzuiger - water / Montagesleutels
Diamantschijf voor beton
Raccord pour aspirateur - eau / Clés de montage
Disque diamanté pour béton

- Geen kick-back en trekt in het materiaal
Pas de rebond et pénètre dans la matière

INCLUSIEF TOEBEHOREN • ACCESSOIRES INCLUS

Aansluiting voor water / Montagesleutels
1 x Diamantschijf voor beton /
Raccord pour eau / Clés de montage
1 x Disque diamanté pour béton

SOFT START



EE 0682E



- Geen kick-back en trekt in het materiaal
Pas de rebond et pénètre dans la matière



NEW

Speciaal voor gebruik met rail
Spécial pour utilisation avec rail



EE 3744N

SET : 2 x geleidingsrail 100 cm + machinehouder
+ 1 x verbindingsstuk + montagestuk
SET : 2 x rail de guidage 100 cm + support de
machine + 1 x connecteur + montage.

EE 3744P

1 x geleidingsrail 100 cm
+ verbindingsstuk + montagestuk
1 x rail de guidage 100 cm
+ connecteur + montage.

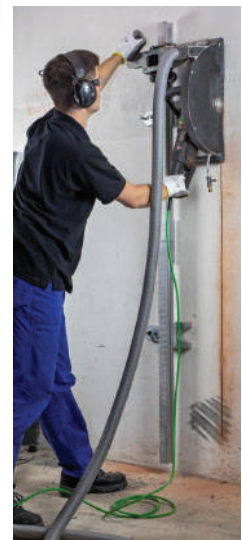

code							min.	€
EE 0682A		4026851018076	2850 Watt	15,400 kg	-	1	1	1647,00
EE 0682E		4026851019547	2850 Watt	13,400 kg	-	1	1	1385,00
Geleidingsrail-set voor ETR • Set rail de guidage pour ETR								
EE 3744N		4026851015693	200 cm	18,500 kg	-	1	1	1125,00
Verlengstuk voor geleidingsrail • Rallonge pour rail de guidage								
EE 3744P		4026851015709	100 cm	6,000 kg	-	1	1	370,00



	EE 06703 EMF 125.2	EE 0671A EMF 150.1	EE 0672C EMF 180.2
	1700W 230V	2300W 230V	2300W 230V
	7500 min ⁻¹	7500 min ⁻¹	3100 min ⁻¹
	-	4300 min ⁻¹	2200 min ⁻¹
	2 x incl. 125 x 22,2 mm	2 x incl. 150 x 22,2 mm	2 x incl. 180 x 22,2 mm
	30 mm	45 mm	60 mm
	30 mm	46 mm	60 mm
	5 m H07RN-F	5 m H07RN-F	5 m H07RN-F
	compatibel	compatibel	compatibel
	3,5 kg	6,1 kg	8,2 kg



EE 06703



EE 0671A

Met afzuigkap
Avec capot d'aspiration



EE 0672C



- Parallele stand van het handvat voor een optimale geleiding.
Position parallèle de la poignée pour un guidage parfait.
- Regelbare diepte- en breedte-instelling.
Réglage de la profondeur et de la largeur de coupe.

INCLUSIEF TOEBEHOREN • ACCESSOIRES INCLUS

- EMF 125.2**
2 x Diamantschijf / Disque diamanté (Ø125 mm)
- EMF 150.1**
2 x Diamantschijf / Disque diamanté (Ø150 mm)
- EMF 180.2**
2 x Diamantschijf / Disque diamanté (Ø180 mm)

code							min.	€
EE 06703	koffer/coffre	4026851017048	Ø 125 mm	7,740 kg	-	1	1	670,00
Afzuigkap met veer • Capot d'aspiration avec ressort								
EE 0671A	koffer/coffre	4026851016201	Ø 150 mm	14,120 kg	20	1	1	780,00
EE 0672C	koffer/coffre	4026851017697	Ø 180 mm	18,060 kg	-	1	1	1087,00



- **Voor stof van klasse L en M.**
Stof met grenswaarden voor beroepsmatige blootstelling > 0,1mg/m³ (Hout, plamuur, verf en lak, plaaster, cement, beton, tegellijm, zand en kiezels)
- **Pour les poussières de classe L et M.**
Poussières avec des valeurs limites d'exposition professionnelle > 0,1mg/m³ (Bois, mastic, peinture et laque, plâtre, ciment, béton, colle à carrelage, sable et cailloux)

De zuiger **DSS 35 M iP** is voorzien van een elektromagnetische filterreining waarmee het opgevangen stof van een filtercassette kan worden afgeschud. De filtercassettes worden afwisselend na elkaar gereinigd, zodat een voortdurend functioneren gegarandeerd is.

L'aspirateur **DSS 35 M iP** est équipé d'un dispositif électromagnétique de nettoyage du filtre permettant d'éliminer par vibration les poussières restant collées aux cassettes à filtre plissé. Les cassettes à filtre plissé sont nettoyées alternativement l'une après l'autre de manière à pouvoir garantir un travail en continu.



TOEBEHOREN VOOR ZUIGERS OP BLZ 44
ACCESSOIRES POUR ASPIRATEURS P. 44

EE 09919
DSS 35 M iP

	Max. 1600W 230V
	25 l
	35 l
	280 mbar
	2 x 4300 cm ²
	55 x 40 x 55 cm
	8 m H07RN-F
	14,0 kg

code				L			min.	€
EE 09919		4026851014818	1600 Watt	25 L	20,500 kg	1	1	969,00



EE 09932



EE 09931

EE 09932 **EE 09931**
ESS 35 LP **ESS 35 MP**

	Max. 1200W 230V
	35 l
	250 mbar
	54 x 39 x 63,5 cm
	10 m H07RN-F
	16,0 kg

- **Voor stof van klasse L.**
Stof met grenswaarden voor beroepsmatige blootstelling > 1mg/m³ (Huishoudelijk stof, aarde, kalk)
- **Pour les poussières de classe L.**
Poussières avec des valeurs limites d'exposition professionnelle > 1mg/m³ (Poussière domestique, terre, chaux)

- **Voor stof van klasse L en M.**
Stof met grenswaarden voor beroepsmatige blootstelling > 0,1mg/m³ (Hout, plamuur, verf en lak, plaaster, cement, beton, tegellijm, zand en kiezels)
- **Pour les poussières de classe L et M.**
Poussières avec des valeurs limites d'exposition professionnelle > 0,1mg/m³ (Bois, mastic, peinture et laque, plâtre, ciment, béton, colle à carrelage, sable et cailloux)



TOEBEHOREN VOOR ZUIGERS OP BLZ 52
ACCESSOIRES POUR ASPIRATEURS P. 52

code				L			min.	€
EE 09932		4026851018427	1200 Watt	35 L	23,000 kg	1	1	615,00
EE 09931		4026851018410	1200 Watt	35 L	23,000 kg	1	1	749,00



Een adapterplaat om alle gangbare gereedschapskisten aan de CraftiX te bevestigen. (Systainer, metaBOX, Tstak Box, L-Boxx, MAKPAC)

Une seule plaque d'adaptation pour fixer toutes les boîtes à outils courantes au CraftiX. (Systainer, metaBOX, Tstak Box, L-Boxx, MAKPAC)

EE 09921
SS 1401 L

	Max. 1250W 230V
	21 l
	25 l
	210 mbar
	3000 cm²
	50,5 x 38,5 x 37,5 cm
	5 m H05VV-F
	7,7 kg

EE 09915
DSS 25 A

Max. 1400W 230V
20 l
25 l
270 mbar
2 x 4300 cm²
45,7 x 40 x 53,5 cm
8 m H05VV-F
11,7 kg



EE 09921



EE 09915



code				L			min.	€
EE 09921		4026851015112	1250 Watt	21 L	9,920 kg	1	1	301,00
EE 09915		4026851013170	1400 Watt	20 L	18,400 kg	1	1	660,00

EE 09927
EPS 50

	Max. 1300W 230V		3,88l/s 14.000l/h
	Max. 900W 230V		46 x 45 x 63 cm
	50 l		10 m H05VV-F
	230 mbar		15,0 kg



- Grondige absorptie en gelijktijdig wegpompen van water tot op 9 m hoogte
- sneller en efficiënter in vergelijking met conventionele methoden
- Op bouwterreinen, bij overstromingen, herstel van brandschade, beschadigingen aan pijpleidingen
- Renovatie van platte daken, reiniging van vijvers of zwembaden en andere reinigingswerkzaamheden
- Voor dakwerkers, bouwbedrijven, brandweer, ...

- Absorption complète et pompage simultané de l'eau jusqu'à une hauteur de 9 m
- Plus rapide et plus efficace que les méthodes conventionnelles
- Sur les chantiers de construction, pour les inondations, la réparation des dommages causés par les incendies, les dommages aux canalisations.
- Rénovation de toits plats, nettoyage d'étangs ou de piscines et autres travaux de nettoyage
- pour les couvreurs, les entreprises de construction, les pompiers, etc.

code				L			min.	€
EE 09927		4026851017574	1300 Watt	50 L	27,760 kg	-	1	1189,00



SS 1401 L

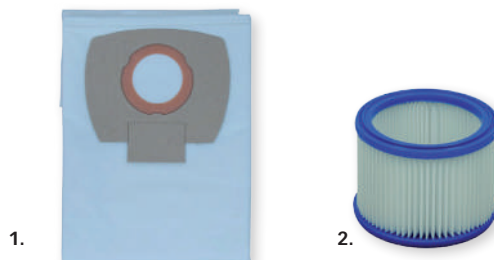

DSS 25 A/50 A DSS 35 M iP

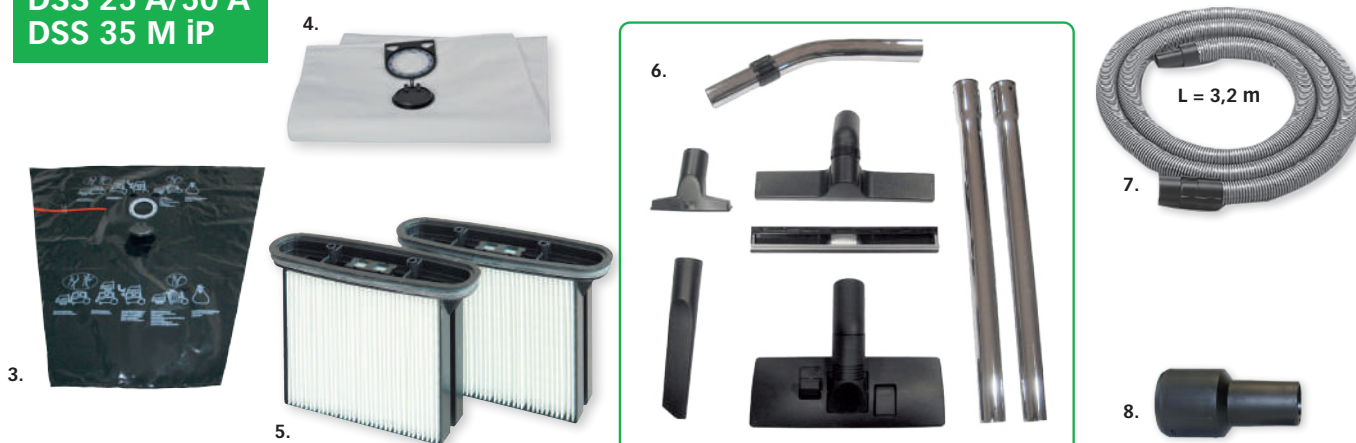

Toebehoren voor stof- en waterafzuiging • Accessoires pour aspirateur

code							min.	€
1. Vlies-filterzak • Sac en non tissé voor / pour SS 1401 L Prijs per 5 st. • Prix par 5 pcs								
EE 35323		4026851014047	SS 1401 L	0,317 kg	-	1	1	35,00
2. Harmonicafilter • Filtre en harmonica voor / pour SS 1401 L								
EE 35322		4026851014030	SS 1401 L	0,710 kg	-	1	1	43,90
3. Filterzak in plastic • Filtre en plastique voor / pour DSS 25/50 A / DSS 35 M iP Prijs per 5 st. • Prix par 5 pcs								
EE 35320		4026851009296	DSS 25 A / DSS 35 M iP / DSS 50 A	1,000 kg	-	1	1	85,20
4. Filterzak in stof • Filtre en tissu voor / pour DSS 25/50 A / DSS 35 M iP Prijs per 5 st. • Prix par 5 pcs								
EE 35321		4026851013460	DSS 25 A / DSS 35 M iP	0,560 kg	-	1	1	52,00
EE 35326		4026851014825	DSS 50 A	0,560 kg	-	1	1	66,00
5. Polyester filterset • Jeu de filtre en polyester voor / pour DSS 25/50 A / DSS 35 M iP Prijs per 2 st. • Prix par 2 pcs								
EE 35301		4026851004307	DSS 25/50 A / DSS 35 M iP	1,133 kg	-	1	1	132,00
6. Set van 7 toebehoren • Set de 7 accessoires voor / pour DSS 25/50 A / DSS 35 M iP								
EE 35315	vrac	4026851004888	DSS 25/50 A / DSS 35 M iP	1,475 kg	-	1	1	68,70
7. Zuigslang • Tuyau d'aspirateur 3,2 m voor / pour DSS 25/50 A / DSS 35 M iP								
EE 35307	vrac	4026851007643	3,2 m - Ø 35 mm	0,500 kg	-	1	1	68,70
8. Slangaansluiting, machinezijde • Raccord de tuyau, côté de la machine voor / pour DSS 25/50 A / DSS 35 M iP								
EE 353135	vrac	4026851010285	DSS 25/50 A / DSS 35 M iP	0,057 kg	-	1	1	23,70