

3

DIAMANTGEREEDSCHAP EN MACHINES OUTILS DIAMANTÉS ET MACHINES

DIAMANTDROOGZAGEN
DIAMANTZAGEN
VOOR DROOG EN NAT GEBRUIK
SLIJKOPPEN EN VOEGENFREZEN

TOEBEHOREN VOOR POLIJSTMACHINES
DIAMANT BOORKRONEN

TOEBEHOREN VOOR TEGELBOREN &
BOORTECHNIEK

ELEKTRISCHE
DIAMANTZAAGMACHINES

DISQUES DIAMANTÉS POUR USAGE À SEC

DISQUES DIAMANTÉS
POUR USAGE À SEC ET USAGE À EAU

DISQUES À SURFACER
ET FRAISES À DÉJOINTOYER

ACCESSOIRES POUR MACHINE À POLIR
COURONNES DIAMANTÉES

ACCESSOIRES POUR FORETS SPECIALE
CARRELAGE & TECHNIQUES DE FORAGE

TRONÇONNEUSES DIAMANTÉES
ÉLECTRIQUES

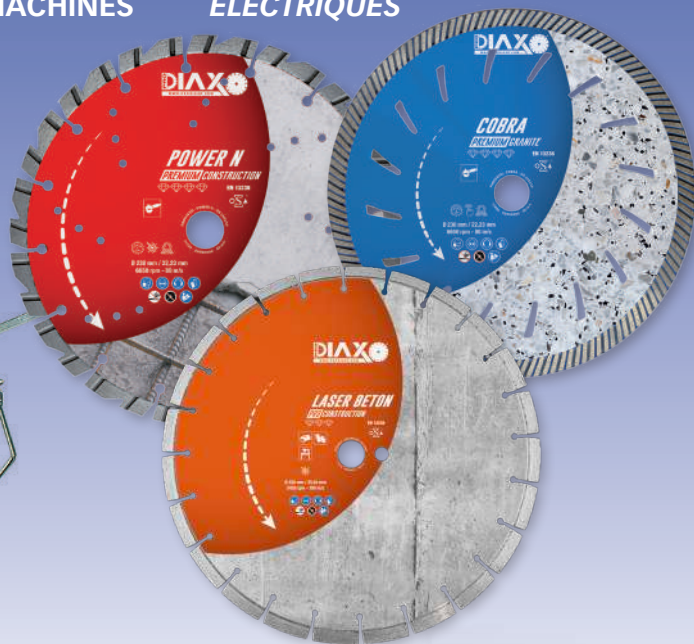

BATTIPAV™

PRO DIAXO®
WWW.PRODIAXO.COM

PRODIA XO QUICK SEARCH 4-STEP

1 BEPAAL DE MACHINE DÉTERMINER LA MACHINE



HAakse slijper
MEULEUSE



SLEUVENZAAG
RAINUREUSE



DOORSLIJPER
TRONÇONNEUSE



AFKORTZAAG
SCIE CIRCULAIRE



TEGELZAAG
COUPE CARRELAGE



TAFELZAAG
TABLE DE SCIAGE



VLOERZAAG
SCIE DE SOL



VERSTEKZAAG
SCIE À ONGLET



SCHUURMACHINE
PONCEUSE

NEW

2 BEPAAL DE DIAMETER EN HET ASGAT DÉTERMINER LE DIAMÈTRE ET L'ALÉSAGE



3 MET OF ZONDER WATERAFKOELING AVEC OU SANS REFOIDISSEMENT À EAU



NAT GEBRUIK
UTILISATION À EAU



DROOG GEBRUIK
UTILISATION À SEC

4 BEPAAL HET KWALITEITSNIVEAU EN HET BEWERKTE MATERIAAL DÉTERMINER LE NIVEAU DE QUALITÉ ET LE MATÉRIAU À TRAVAILLER

LEVENSDUUR
LONGÉVITÉ

PERFORMANCE

BASIC



PRO



PREMIUM



TOP



CONSTRUCTION

KLINKERS...
CLINKERS...

BETON...
BÉTON...

BAKSTEEN...
BRIQUES...



GRANITE | CERAMICS

NATUURSTEEN...
PIERRE NATURELLE...

TEGELS...
CARRELAGES...

ARDUIN...
PIERRE BLEUE...

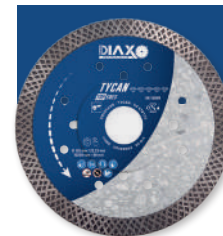

SPECIAL

VEZELCEMENTPLATEN...
PLAQUES CIMENTÉES...

CELLENBETON...
BÉTON CELLULAIRE...

ASFALT...
ASPHALTE...



PRODIAXO QUICK SEARCH

KARAKTERISTIEKEN CARACTÉRISTIQUES



**LASERGEST
SOUDÉS LASER**



SPEED CUT



SILENT



LONG LIFE



Organisation for the Safety of Abrasives

CUBIX TECHNOLOGY



Revolutionaire technologie waarbij de verdeling van de diamanten in de segmenten op een gelijkmatige en gestructureerde manier gebeurt. Deze optimale verdeling resulteert in langere levensduur, gelijkmatige slijtage en een snelle snede.

Technologie révolutionnaire qui permet à chaque grain de diamant d'être placé de façon structurée dans un segment. Cette structure optimale permet une plus grande longévité ainsi qu'une usure uniforme et une haute performance de la vitesse de coupe.

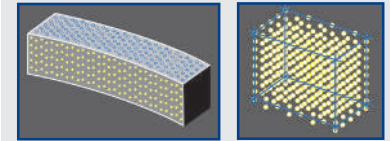

Kwaliteitsniveau
Niveau de qualité

Benaming van de schijf
Dénomination du disque

NEW

OSA logo

Karakteristieken
Caractéristiques

Afmetingen
Dimensions

Bewerkte materiaal en derivaten
Matériau à travailler et dérivés

Veiligheidsindicatie
Indications de sécurité

Geschikte machine
Machine adaptée

UNIVERSAL
BASIC CONSTRUCTION

EN 13236



Algemene bouwmaterialen, niet gewapend beton, klinkers, dakpannen, boordstenen
 Matériaux de construction générale, béton non armé, clinkers, tuiles, bordures

code										min.	€
			mm	mm	mm	mm					
DX 110115		5420000019928	115	22,2	10	2	107 gr	-	1	1	8,30
DX 110125		5420000019935	125	22,2	10	2,3	144 gr	-	1	1	9,90
DX 110230		5420000019942	230	22,2	10	2,3	618 gr	-	1	1	24,70
Prijs per 5 st. • Prix par 5 pcs											
DX 110199		5420000058842	125	22,2	10	2,3	750 gr	-	1	1	41,50
Prijs per 3 st. • Prix par 3 pcs											
DX 110298		5420000058859	230	22,2	10	2,8	1920 gr	-	1	1	66,20

LASER UNI
PRO CONSTRUCTION

EN 13236



Betonblokken, klinkers, middelharde materialen
 Blocs béton, clinkers, matériaux demi-durs

code										min.	€
			mm	mm	mm	mm					
DX 112301		5420000019959	300	25,4	10	3,0	1246 gr	-	1	1	90,30
DX 112351		5420000019966	350	25,4	10	3,2	1773 gr	-	1	1	108,00
DX 112401*	vrac	5420000027084	400	25,4	10	3,6	2250 gr	-	1	1	138,00



* niet bedrukt / non imprimé



**LASER BETON
PRO CONSTRUCTION**























EN 13236  



**Beton, gewapend beton, klinkers, boordstenen
Béton, béton armé, clinkers, bordures**



code										min.	€
			mm	mm	mm	mm					
DX 250115		5420000019973	115	22,2	10	2,2	128 gr	-	1	1	20,00
DX 250125		5420000019980	125	22,2	10	2,2	150 gr	-	1	1	21,30
DX 250128		5420000064911	125	X-LOCK / 22,2	10	2,2	160 gr	-	1	1	22,30
DX 250140		5420000025387	140	22,2	10	2,4	200 gr	-	1	1	32,80
DX 250150		5420000022331	150	22,2	10	2,4	225 gr	-	1	1	35,20
DX 250230		5420000019997	230	22,2	10	2,6	604 gr	-	1	1	45,90
DX 250301		5420000020009	300	25,4	10	3,0	1226 gr	-	1	1	93,00
DX 250350		5420000024939	350	20,0	10	3,2	1793 gr	-	1	1	115,00
DX 250351		5420000020016	350	25,4	10	3,2	1804 gr	-	1	1	115,00
DX 250400*	vrac	5420000069794	400	20,0	10	3,2	2250 gr	-	1	1	149,00
DX 250401*	vrac	5420000023505	400	25,4	10	3,2	2250 gr	-	1	1	149,00
DX 250451*	vrac	5420000024557	450	25,4	10	3,6	3815 gr	-	1	1	203,00
DX 250501*	vrac	5420000024243	500	25,4	10	3,6	4625 gr	-	1	1	249,00
DX 250601*	vrac	5420000024564	600	25,4	10	4,0	7900 gr	-	1	1	300,00
DX 250705*	vrac	5420000024571	700	55,0	10	4,5	11250 gr	-	1	1	486,00
Prijs per 5 st. • Prix par 5 pcs											
DX 250199		5420000058866	125	22,2	10	2,2	750 gr	-	1	1	84,10
Prijs per 3 st. • Prix par 3 pcs											
DX 250298		5420000058873	230	22,2	10	2,6	1950 gr	-	1	1	103,00













**BATTERY BLADE SILENT CORE
PRO CONSTRUCTION**



 EN 13236   

FOR BATTERY MACHINES

**Algemene bouwmaterialen, beton, gewapend beton, natuursteen
Matériaux de construction générale, béton, béton armé, pierre naturelle**

code										min.	€
			mm	mm	mm	mm					
DX 225125		5420000068674	125	22,2	10	2	150 gr	-	1	1	28,00
DX 225230		5420000068681	230	22,2	10	2,2	480 gr	-	1	1	55,00
DX 225301		5420000068698	300	25,4	10	2,6	1000 gr	-	1	1	94,00
DX 225351		5420000068704	350	25,4	10	2,8	1480 gr	-	1	1	108,00

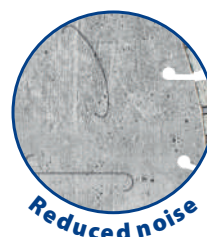















* niet bedrukt / non imprimé

PERFORMER
PRO CONSTRUCTION

XLOCK

Algemene bouwmaterialen, beton, klinkers, dakpannen, boordstenen
Matériaux de construction générale, béton, clinkers, tuiles, bordures











code										min.	€
			mm	mm	mm	mm					
DX 440115		5420000018747	115	22,2	10	1,8	160 gr	-	1	1	26,80
DX 440125		5420000018754	125	22,2	10	2,1	199 gr	-	1	1	29,80
DX 441126		5420000064928	125	X-LOCK / 22,2	10	2,2	199 gr	-	1	1	32,90
DX 440150		5420000023499	150	22,2	10	2,4	234 gr	-	1	1	46,20
DX 440180		5420000024328	180	22,2	10	2,5	376 gr	-	1	1	52,50
DX 440230		5420000018761	230	22,2	10	2,8	713 gr	-	1	1	64,00

PERFORMER
PRO CONSTRUCTION

EN 13236

M14

NEW
Algemene bouwmaterialen, beton, klinkers, dakpannen, boordstenen
Matériaux de construction générale, béton, clinkers, tuiles, bordures

code										min.	€
			mm	mm	mm	mm					
DX 440127		5420000067172	125	M14	10	2,2	182 gr	-	1	1	35,90
DX 440237*		5420000070158	230	M14	10	2,4	713 gr	-	1	1	72,00











* Beschikbaar vanaf 04/2024 • Disponible à partir du 04/2024



Aansluiting M14 Raccordement

WAVED TURBO
PRO CONSTRUCTION

Baksteen middelhard, proton, vezelcementplaten
Briques demi-durs, proton, plaques cimentées









code										min.	€
			mm	mm	mm	mm					
DX 430125		5420000020412	125	22,2	7	2,2	139 gr	-	1	1	24,40
DX 430230		5420000020429	230	22,2	8	2,8	656 gr	-	1	1	65,50

**LASER UNI TURBO
PRO CONSTRUCTION**

EN 13236  



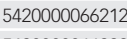
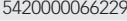

**Betonblokken, klinkers, middelharde materialen
Blocs béton, clinkers, matériaux demi-durs**

code								min.	€	
		mm	mm	mm	mm					
DX 115501*	 5420000066205	500	25,4	10	3,6	4200 gr	-	1	1	169,00
DX 115601*	 5420000066212	600	25,4	10	4,0	7300 gr	-	1	1	275,00
DX 115701*	 5420000066229	700	25,4	10	4,8	10100 gr	-	1	1	387,00













**BETOBLOC BAU
PRO CONSTRUCTION**

 EN 13236 

**Betonblokken (snelbouw), holle bakstenen (zeer grote)
Blocs béton (construction rapide), briques creuses (très grandes)**

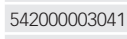
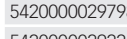

code								min.	€	
		mm	mm	mm	mm					
DX 254602*	vrac  5420000044395	600	30,0	10	4,6	2500 gr	-	1	1	293,00
DX 254651*	vrac  5420000030411	650	25,4	10	4,6	3000 gr	-	1	1	352,00
DX 254754*	vrac  5420000029798	750	60,0/40,0	10	4,6	11750 gr	-	1	1	527,00
DX 254906*	vrac  5420000029224	900	60,0	10	4,6	13250 gr	-	1	1	659,00















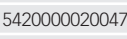
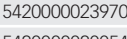

**MASTER BETON
PREMIUM CONSTRUCTION**

EN 13236 

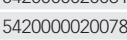
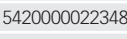
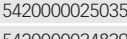

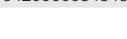
**Betonblokken, gewapend beton, harde tot zeer harde materialen
Blocs béton, béton armé, matériaux durs**

code								min.	€	
		mm	mm	mm	mm					
DX 253350	 5420000023963	350	20,0	10	2,8	1683 gr	-	1	1	149,00
DX 253351	 5420000020047	350	25,4	10	2,8	1715 gr	-	1	1	149,00
DX 253400*	 5420000023970	400	20,0	10	3,2	2460 gr	-	1	1	179,00
DX 253401*	vrac  5420000020054	400	25,4	10	3,2	2584 gr	-	1	1	179,00
DX 253451*	vrac  5420000020061	450	25,4	10	3,6	3840 gr	-	1	1	223,00
DX 253501*	vrac  5420000020078	500	25,4	10	3,6	4670 gr	-	1	1	314,00
DX 253601*	vrac  5420000022348	600	25,4	10	4,5	7900 gr	-	1	1	374,00
DX 253651*	vrac  5420000025035	650	25,4	10	4,5	9800 gr	-	1	1	429,00
DX 253701*	vrac  5420000034839	700	25,4	10	4,5	11250 gr	-	1	1	637,00
DX 253706*	vrac  5420000034846	700	60,0/55,0	10	4,8	11250 gr	-	1	1	637,00

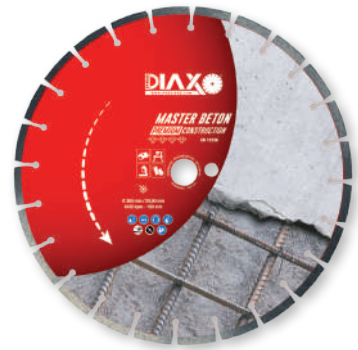

**DX 253706 :
2 EXTRA ZIJGATEN 13 mm !
2 TROUS EXTRA 13 mm !**

* niet bedrukt / non imprimé

POWER N PREMIUM CONSTRUCTION

EN 13236



TOP!

Beton, gewapend beton, harde klinkers, boordstenen
Béton, béton armé, clinkers durs, bordures



X-LOCK

code									min.	€	
		mm	mm	mm	mm						
DX 290115		5420000020269	115	22,2	10	2,6	137 gr	-	1	1	32,00
DX 290125		5420000020276	125	22,2	10	2,6	160 gr	-	1	1	34,00
DX 291126		5420000064959	125	X-LOCK / 22,2	10	2,4	160 gr	-	1	1	39,50
DX 290230		5420000020283	230	22,2	10	2,8	589 gr	-	1	1	89,00
DX 290301		5420000024113	300	25,4	10	3,0	1303 gr	-	1	1	125,00
DX 290350		5420000064119	350	20,0	10	3,0	1800 gr	-	1	1	149,00
DX 290351		5420000024120	350	25,4	10	3,0	1825 gr	-	1	1	149,00
DX 290400*		5420000065420	400	20,0	10	3,0	2250 gr	-	1	1	169,00
DX 290401*		5420000032569	400	25,4	10	3,0	2250 gr	-	1	1	169,00

POWER XTM TOP CONSTRUCTION



EN 13236



TOP!

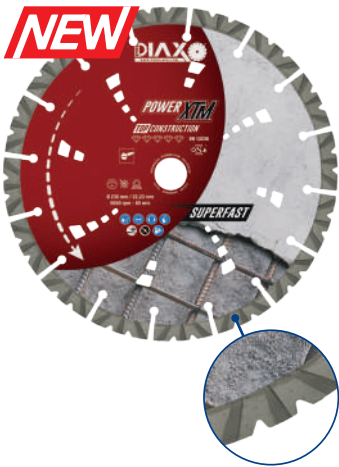

Beton, gewapend beton, harde klinkers, boordstenen
Béton, béton armé, clinkers durs, bordures

code									min.	€	
		mm	mm	mm	mm						
DX 297125		5420000068971	125	22,2	12	2,4	160 gr	-	1	1	42,00
DX 297150		5420000070165	150	22,2	12	2,6	196 gr	-	1	1	45,00
DX 297180		5420000070172	180	22,2	12	2,6	230 gr	-	1	1	58,00
DX 297230		5420000068988	230	22,2	12	2,6	700 gr	-	1	1	96,00
DX 297301		5420000068995	300	25,4	12	2,8	1200 gr	-	1	1	139,00
DX 297350		5420000069008	350	22,2	12	3,2	1800 gr	-	1	1	169,00
DX 297351		5420000069015	350	25,4	12	3,2	1800 gr	-	1	1	169,00
DX 297401*		5420000069022	400	25,4	12	3,2	2400 gr	-	1	1	201,00

SUPERFAST



* niet bedrukt / non imprimé



**BLADE RUNNER
TOP CONSTRUCTION**













EN 13236   

TOP!  & 

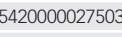
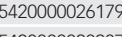
**Grindtegels, beton, sterk gewapend beton, kandla
Dalles gravillonnées, béton, béton fortement armé, kandla**

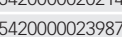
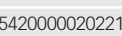
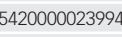
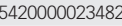

code								min.	€	
		mm	mm	mm	mm					
DX 275150	 5420000027503	150	22,2	10	2,2	196 gr	-	1	1	72,00
DX 275200	 5420000026179	200	22,2	10	2,4	414 gr	-	1	1	85,00
DX 275230	 5420000020207	230	22,2	12	2,7	580 gr	-	1	1	109,00
DX 275301	 5420000020214	300	25,4	12	2,8	1054 gr	-	1	1	178,00
DX 275350	 5420000023987	350	20,0	12	2,8	1676 gr	-	1	1	219,00
DX 275351	 5420000020221	350	25,4	12	2,8	1671 gr	-	1	1	219,00
DX 275400*	 5420000023994	400	20,0	12	3,2	2497 gr	-	1	1	256,00
DX 275401*	 5420000023482	400	25,4	12	3,2	2476 gr	-	1	1	256,00



"Kandla": platte (± 4-5 cm) natuurlijke zandsteen
"Kandla": grès naturel, plat (± 4-5 cm)







**ECLIPSE SILENCE
TOP CONSTRUCTION**

 **PLUS+**



 EN 13236    

**Beton, gewapend beton, harde klinkers, boordstenen
Béton, béton armé, clinkers durs, bordures**

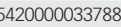
code								min.	€	
		mm	mm	mm	mm					
DX 280230	 5420000033788	230	22,2	15	2,5	850 gr	-	1	1	119,50

"Sandwich" Core

15 mm!



**STEELMASTER
TOP CONSTRUCTION**











EN 13236   

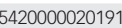

**Harde materialen, gewapend beton, ijzer, I profielen
Matériaux durs, béton armé, fer, profilés I**

code								min.	€	
		mm	mm	mm	mm					
DX 270230	 5420000020191	230	22,2	10	2,4	597 gr	-	1	1	98,80



Dankzij zijn metaallegering gaat deze schijf even makkelijk doorheen metaal alsook door de hardste materialen zoals gewapend beton

Grâce à son alliage, le disque coupe aussi bien l'acier que les matériaux les plus durs comme béton armé

* niet bedrukt / non imprimé

TURBO ABRASIV
PRO CONSTRUCTION

Baksteen zacht, asfalt, gasbeton, abrasieve materialen
 Briques tendres, asphalte, béton cellulaire, matériaux abrasifs

code											€
			mm	mm	mm	mm					
DX 425115		5420000020368	115	22,2	7	2,2	119 gr	-	1	1	20,20
DX 425125		5420000020375	125	22,2	7	2,2	138 gr	-	1	1	24,40
DX 425150		5420000020382	150	22,2	7	2,2	195 gr	-	1	1	33,30
DX 425230		5420000020399	230	22,2	9	2,8	655 gr	-	1	1	61,90

RESCUE
PREMIUM CONSTRUCTION

EN 13236



Alle steensoorten (behalve abrasieve materialen), metalen, gietijzer, hout, glas ...
 Tous les matériaux (sauf matériaux abrasifs), métaux, fonte, bois, verres ...

code											€
			mm	mm	mm	mm					
DX 375125		5420000043299	125	22,2	8	2,8	400 gr	-	1	1	49,10
DX 375230		5420000020351	230	22,2	8	2,7	572 gr	-	1	1	149,00

"MULTI USE"

"Multifunctioneel blad "allrounder" speciaal ontwikkeld voor urgentieinterventies
 Alle steensoorten (behalve abrasieve materialen) - kunststoffen - metalen - hout - rubber - glas
 Disque polyvalent pour application variée pour toutes les interventions d'urgence
 Coupent tous les matériaux (sauf matériaux abrasifs) : pierre artificielle et naturelle
 métaux - plastique - bois - caoutchoucs - verres

C-FIBER-TURBO
PREMIUM CONSTRUCTION

Sidings, vezelcementplaten, tegels
 Sidings, plaques cimentées, carrelages

VOOR VEZELCEMENT
POUR FIBRE-CIMENT









code											€
			mm	mm	mm	mm					
DX 602125		5420000028975	125	22,2	7	1,4	100 gr	-	1	1	37,00
DX 602202		5420000028982	200	30,0	7	1,8	366 gr	-	1	1	63,60
DX 602232		5420000028999	230	30,0	7	1,8	449 gr	-	1	1	69,90
DX 602302		5420000029002	300	30,0	7	2,6	975 gr	-	1	1	116,00

**LASER COMBI BETON/ASPHALT
PRO CONSTRUCTION**

EN 13236  

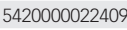

Beton & asfalt • Béton & asphalte

code								min.	€	
		mm	mm	mm	mm					
DX 266350	 5420000023857	350	20,0	10	3,2	1941 gr	-	1	1	114,50
DX 266351	 5420000022409	350	25,4	10	3,2	1937 gr	-	1	1	114,50









**MASTER COMBI BETON/ASPHALT
PREMIUM CONSTRUCTION**

 EN 13236 

TOP!

Beton & asfalt • Béton & asphalte

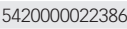

code								min.	€	
		mm	mm	mm	mm					
DX 268351	 5420000022386	350	25,4	13+2	2,8	1823 gr	-	1	1	235,00











**LASER ASPHALT
PRO CONSTRUCTION**

EN 13236  

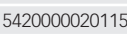

Asfalt • Asphalte

code								min.	€	
		mm	mm	mm	mm					
DX 260301	 5420000020108	300	25,4	10	2,8	1231 gr	-	1	1	112,00
DX 260351	 5420000020115	350	25,4	10	3,0	1679 gr	-	1	1	147,00













**MASTER ASPHALT
PREMIUM CONSTRUCTION**

 EN 13236 

TOP!

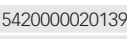
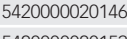
Asfalt • Asphalte

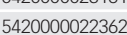

code								min.	€	
		mm	mm	mm	mm					
DX 261351	 5420000020139	350	25,4	10	3,2	1707 gr	-	1	1	209,00
DX 261401*	 5420000020146	400	25,4	10	3,5	2663 gr	-	1	1	282,00
DX 261451*	 5420000020153	450	25,4	10	4,0	3955 gr	-	1	1	325,00
DX 261501*	 5420000023161	500	25,4	10	4,0	4798 gr	-	1	1	350,00
DX 261601*	 5420000022362	600	25,4	10	4,5	6000 gr	-	1	1	360,00



* niet bedrukt / non imprimé

PANTHER

PREMIUM GRANITE / CONSTRUCTION



Harde tegels, marmer, graniet, dakpannen, bouwmaterialen, beton
Carrelages durs, marbre, granite, tuiles, matériaux de construction, béton

code			mm	mm	mm	mm			min.	€
DX 330115		5420000018716	115	22,2	10	2,2	170 gr	-	1 1	33,30
DX 330125		5420000018723	125	22,2	10	2,2	195 gr	-	1 1	37,50
DX 330180		5420000024595	180	22,2	10	3,0	399 gr	-	1 1	48,60
DX 330230		5420000018730	230	22,2	12	3,0	725 gr	-	1 1	79,00
DX 330300		5420000020290	300	20,0	10	3,0	1328 gr	-	1 1	149,00
DX 330301		5420000020306	300	25,4	10	3,0	1316 gr	-	1 1	149,00
DX 330351		5420000020320	350	25,4	10	3,5	2013 gr	-	1 1	185,00

COBRA

PREMIUM GRANITE



Harde tegels, marmer, graniet
Carrelages durs, marbre, granite



code			mm	mm	mm	mm			min.	€
DX 345115		5420000068728	115	22,2	10	2,5	125 gr	-	1 1	31,50
DX 345125		5420000020337	125	22,2	10	2,5	160 gr	-	1 1	45,20
DX 346126		5420000064942	125	X-LOCK / 22,2	10	2,5	160 gr	-	1 1	47,90
DX 345230		5420000020344	230	22,2	12	2,8	632 gr	-	1 1	95,20













RIM
BASIC CERAMICS

EN 13236 



Keramische wandtegels • Carrelages murales en céramiques

code										min.	€
			mm	mm	mm	mm					
DX 507115		5420000020436	115	22,2	6	2,2	117 gr	-	1	1	10,70
DX 507125		5420000020443	125	22,2	6	2,2	135 gr	-	1	1	13,70



















DOLPHIN RIM
PRO CERAMICS

EN 13236 

 Ø 115 / Ø 125 mm
Ø 180 → Ø 350 mm

Keramische tegels (+ hard)
Carrelages céramiques (+ durs)

















code										min.	€
			mm	mm	mm	mm					
DX 550115		5420000018778	115	22,2	7	1,4	116 gr	-	1	1	17,80
DX 550125		5420000018785	125	22,2	7	1,4	137 gr	-	1	1	19,70
DX 550181		5420000020450	180	25,4	7	1,6	282 gr	-	1	1	34,50
DX 550201		5420000020467	200	25,4	7	1,6	364 gr	-	1	1	36,50
DX 550231		5420000020474	230	25,4	7	1,6	453 gr	-	1	1	48,00
DX 550251		5420000020481	250	25,4	7	1,6	562 gr	-	1	1	68,00
DX 550302		5420000020498	300	30/25,4	7	2,0	1010 gr	-	1	1	115,00
DX 550352		5420000020504	350	30/25,4	7	2,0	1356 gr	-	1	1	142,00

OCTOPUS T TURBO
PREMIUM CERAMICS

EN 13236   

 Ø 115 / Ø 125 mm  Ø 150 → Ø 300 mm

Gres tegels • Carrelages grès

code										min.	€
			mm	mm	mm	mm					
DX 600115		5420000018792	115	22,2	7	1,4	108 gr	-	1	1	22,00
DX 600125		5420000018808	125	22,2	7	1,4	120 gr	-	1	1	23,80
DX 601181		5420000030091	180	25,4	7	1,4	340 gr	-	1	1	47,60
DX 601201		5420000030107	200	25,4	7	1,6	446 gr	-	1	1	57,10
DX 601230		5420000030114	230	22,2	7	1,6	530 gr	-	1	1	60,10
DX 601231		5420000030121	230	25,4	7	1,6	530 gr	-	1	1	60,10



PRECISION THIN RIM PREMIUM CERAMICS



Gres tegels • Carrelages grès

code										min.	€
			mm	mm	mm	mm					
DX 661125		5420000037366	125	22,2	5	1,2	120 gr	-	1	1	22,30
DX 662126		5420000064966	125	X-LOCK / 22,2	5	1,2	120 gr	-	1	1	26,90

VIPER TOP CERAMICS



**EXTRA FINE !
TILES ONLY !!!**

Gres tegels • Carrelages grès

code										min.	€
			mm	mm	mm	mm					
DX 675115		5420000024137	115	22,2	10	1,4	106 gr	-	1	1	26,00
DX 675125		5420000024144	125	22,2	10	1,4	130 gr	-	1	1	28,20
DX 676126		5420000065727	125	X-LOCK / 22,2	10	1,4	130 gr	-	1	1	34,00
DX 675199		5420000058880	125	22,2	10	1,4	600 gr	-	1	1	122,00

Prijs per 5 st. • Prix par 5 pcs



TYCAN TOP GRES



TOP!

Gres, harde tegels, graniet, porselein
Grès, carreaux durs, granite, porcelaine

code										min.	€
			mm	mm	mm	mm					
DX 678115		5420000067783	115	22,2	10,5	1,3	125 gr	-	1	1	32,00
DX 678125		5420000067790	125	22,2	10,5	1,3	140 gr	-	1	1	36,00

- FASTER**
- PERFECT FINISHING**
- SILENT**

PYTHON
TOP GRES



Gres tegels • Carrelages grès

code								€
		mm	mm	mm	mm			
DX 680126		5420000064935	125	X-LOCK / 22,2	10	1,4	125 gr	- 1 1 36,00

X-LOCK

MAMBA
PREMIUM GRANITE



Graniet, natuursteen, keramiek, porselein
Granite, pierre naturelle, céramique, porcelaine



code								€
		mm	mm	mm	mm			
DX 672000		5420000067806	125	22,2	25	2,0	174 gr	- 1 1 49,00

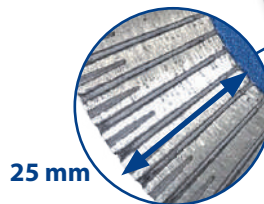
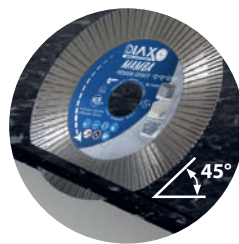
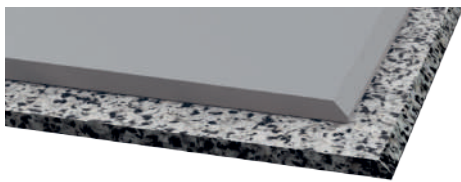

AFKANTEN & POLIJSTEN
BISEAUTER & POLISAGE
ADVANCED TECHNOLOGY

Duo - Disc
PREMIUM GRANITE/CONSTRUCTION

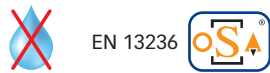

Natuursteen • Pierre naturelle

SNIJDEN & POLIJSTEN
COUPER & POLIR

code							€
		mm	mm				
DX 700125		5420000018877	125	M14	266 gr	- 1 1 76,00	

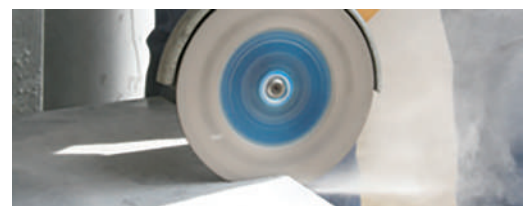

SUPER GRES TOP CERAMICS

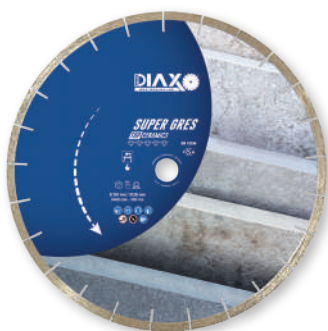

10 mm !



EN 13236



Hardste keramische tegels, gres tegels, natuursteen (met een dikte tot 40 mm) en graniet
Céramique, grès durs, pierre naturelle (jusqu'à 40 mm d'épaisseur) et granite

code									min.	€	
			mm	mm	mm	mm					
DX 635181		5420000062610	180	25,4	10	2,4	408 gr	-	1	1	76,30
DX 635201		5420000062627	200	25,4	10	2,4	472 gr	-	1	1	88,50
DX 635231		5420000047440	230	25,4	10	2,4	658 gr	-	1	1	95,20
DX 635251		5420000047457	250	25,4	10	2,4	812 gr	-	1	1	137,80
DX 635301		5420000047464	300	30,0/25,4	10	2,6	1300 gr	-	1	1	196,00
DX 635351		5420000047471	350	30,0/25,4	10	2,8	1906 gr	-	1	1	217,00

"Sandwich" Core

MARMOR TOP CERAMICS

Marmer, keramische tegels, gres tegels
Marbre, carrelage en céramique et en grès

EN 13236



code									min.	€	
			mm	mm	mm	mm					
DX 681180		5420000043305	180	22,2	7	1,7	380 gr	-	1	1	46,60
DX 681231		5420000029750	230	25,4	7	1,7	413 gr	-	1	1	68,70
DX 681251		5420000029767	250	25,4	7	1,7	576 gr	-	1	1	86,50
DX 681351		5420000020542	350	25,4	7	2,0	1369 gr	-	1	1	210,00



MARMOR PRO CERAMICS

Marmer • Marbre



code									min.	€	
			mm	mm	mm	mm					
DX 683125		5420000029729	125	22,2	3,2	2,2	117 gr	-	1	1	26,70
DX 683231		5420000029736	230	25,4	2,9	2,5	634 gr	-	1	1	55,80
DX 683351		5420000029743	350	25,4	4,0	3,2	1546 gr	-	1	1	114,00

**TOEBEHOREN VOOR DIAMANTSCHIJVEN
ACCESSOIRES POUR DISQUES DIAMANTÉS**

Reduceerring • Bague de réduction

code							min.	€		
			mm	mm	mm					
DX 960029	vrac	5420000033979	30,0 >	20,0	2,0	6 gr	-	1	1	7,08
DX 960041	vrac	5420000034075	30,0 >	25,4	1,4	2 gr	-	1	1	7,08
DX 960030	vrac	5420000033986	30,0 >	25,4	2,0	3 gr	-	1	1	7,08
DX 960037	vrac	5420000034051	25,4 >	15,0	1,8	5 gr	-	1	1	5,62
DX 960042	vrac	5420000034082	25,4 >	20,0	1,4	2 gr	-	1	1	5,62
DX 960032	vrac	5420000034006	25,4 >	20,0	2,0	3 gr	-	1	1	5,62
DX 960033	vrac	5420000034013	25,4 >	20,0	3,2	5 gr	-	1	1	5,62
DX 960034	vrac	5420000034020	25,4 >	22,2	1,4	1 gr	-	1	1	5,62
DX 960031	vrac	5420000033993	25,4 >	22,2	1,6	1 gr	-	1	1	5,62
SPECIAL STIHL®										
DX 960043	vrac	5420000034099	25,4 >	20,0	10	14 gr	-	1	1	12,20

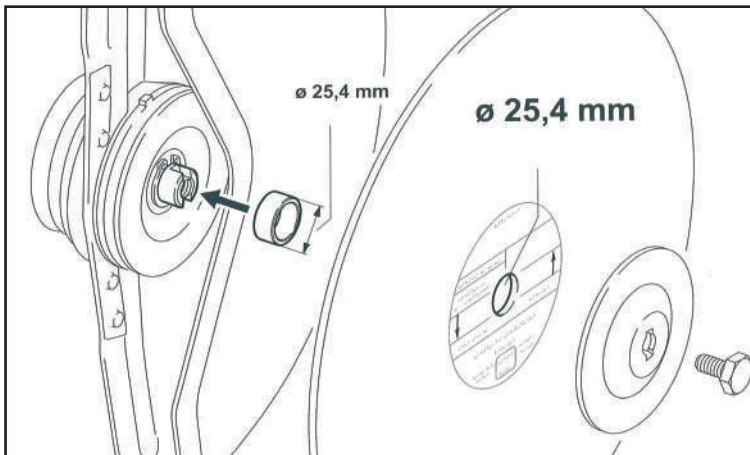

Slijpsteen • Pierre d'affutage















code							min.	€	
				mm					
EE 35910	vrac	4026851006738		200 x 100 x 50	1705 gr	-	1	1	23,70

Blauwe prijs • Prix bleu

GC - HARD
PREMIUM CONSTRUCTION

EN 13236











Harde materialen, beton • Matériaux durs, béton

code										min.	€
			mm	mm	mm	mm					
DX 731100		5420000046504	100	22,2	8,0	4,5	360 gr	-	1	1	60,60
DX 731125		5420000046481	125	22,2	8,0	4,5	480 gr	-	1	1	78,00
DX 731150		5420000070189	150	22,2	8,0	4,5	537 gr	-	1	1	98,00
DX 731180		5420000070196	180	22,2	8,0	4,5	762 gr	-	1	1	119,00

GC - SOFT
PREMIUM CONSTRUCTION

EN 13236













Abrasieve materialen (verse beton)
Matériaux abrasifs (béton frais)

code										min.	€
			mm	mm	mm	mm					
DX 732125		5420000020603	125	22,2	8,3	4,9	472 gr	-	1	1	75,90

TURBO GC-HARD
PREMIUM CONSTRUCTION

EN 13236

Harde beton • Béton dur

code										min.	€
			mm	mm	mm	mm					
DX 733125		5420000024090	125	22,2	8,5	4,5	454 gr	-	1	1	69,30
DX 733180		5420000024106	180	22,2	8,5	4,5	1097 gr	-	1	1	108,00









**DIATOP PLUS
TOP CONSTRUCTION**

EN 13236 

Agressieve vertanding
Denture plus agressive

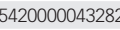

Harde beton • Béton dur

code							min.	€
DX 734125	 542000043282	125	22,2	360 gr	-	1	1	81,50



**PCD-HARD
PREMIUM CONSTRUCTION**









EN 13236



Epoxy coating, lijmen, dekvloeren en bitumen
Revêtement en résine, colles, chape et bitume

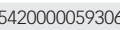

code							min.	€
DX 736126	 542000059306	125	22,2	480 gr	-	1	1	183,00

**MULTI-TASK
PREMIUM CONSTRUCTION**



EN 13236





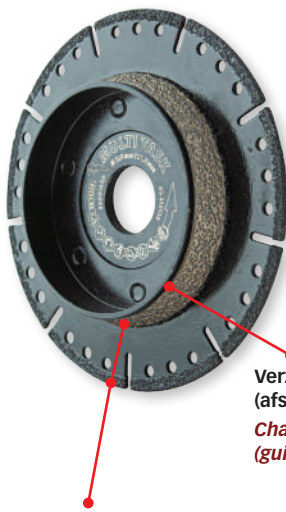



Rioolbuizen in PVC / PE / PU / PRV
Canalisations en PVC / PE / PU / PRV



Verzorgde en gelijkmatige afschuining
(afschuiningsgeleider)
*Chanfrein net et régulier
(guide de chanfreinage)*

Carbide diamanten op de snij-
en afschuiningsvlakken
*Diamants électrodéposés sur les
sections de coupe et de chanfreinage*

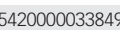
code							min.	€
DX 215125	 542000033849	125	22,2	348 gr	-	1	1	112,00



Snijden en afschuinen in één enkele handeling
Coupe et chanfreine en une seule opération

Veilig afschuinen
Chanfreinage sécurisé

Zeer lange levensduur
Très longue durée de vie





Rubber steunschijf "Flexibel" voor nat & droog gebruik Support "Flexible" pour patins de polissage pour utilisation à eau et à sec



code								min.	€
DX 745100		5420000034617	M14	100 mm	0,101 kg	-	1	1	17,97
DX 745125		5420000068605	M14	125 mm	0,170 kg	-	1	1	18,00

Set Diamantpads - "3-STEP" systeem droog en nat polijsten Patins de polissage en set - système "3-STEP" polissage à eau et à sec



code								min.	€
DX 750500		5420000034624	H1 → H3	100 mm	0,325 kg	-	1	1	108,30

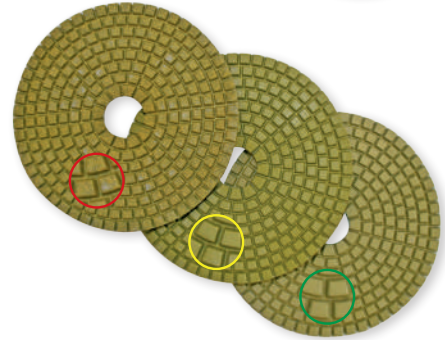

Set Diamantpads - "7-STEP" systeem nat polijsten Patins de polissage en set - système "7-STEP" polissage à eau



code								min.	€
DX 752100		5420000034631	Zie tabel Voir tableau	100 mm	0,780 kg	-	1	1	114,50

Color	# Grit
	50
	100
	200
	400
	800
	1500
	3000



Diamantpads - nat polijsten • Patins de polissage - polissage à eau



code								min.	€	
Prijs per 3 st. • Prix par 3 pcs										
DX 752201		5420000034648	50		100 mm	0,325 kg	-	1	1	54,50
DX 752202		5420000034655	100		100 mm	0,325 kg	-	1	1	54,50
DX 752203		5420000034662	200		100 mm	0,325 kg	-	1	1	54,50
DX 752204		5420000034679	400		100 mm	0,325 kg	-	1	1	54,50
DX 752205		5420000034686	800		100 mm	0,325 kg	-	1	1	54,50
DX 752206		5420000034693	1500		100 mm	0,325 kg	-	1	1	54,50





Honingraatstructuur op basis van kunsthars met een zeer hoge diamantconcentratie. Hoog schuurvermogen en lange levensduur.
Structure en nid d'abeille liée à la résine synthétique avec très forte concentration de diamants. Force d'abrasion et durée de vie élevées.



Achterkant uit nylon voor een eenvoudige aansluiting en verwijdering.
Dos en nylon pour une connexion et un retrait facile.



Snel polijsten en geen kleurvervaging.
Polissage rapide et absence de décoloration.



Flexibele schijf.
Disque flexible.



Min. 3000 tpm
Max. 4500 tpm

Toepassing • Application



Graniet
Granite

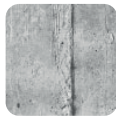

Beton
Béton



Marmer
Marbre

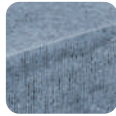

Arduin
Pierre bleue

NEW

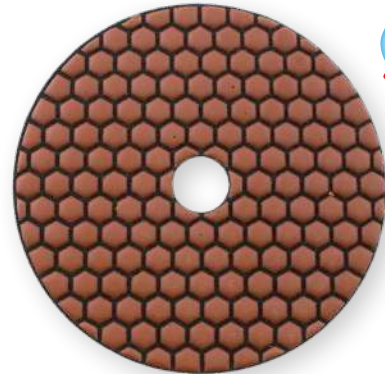

DX 751908



7-Steps

		K50 Ø 125 mm	1	Grof Grossier
		K100 Ø 125 mm	2	
		K200 Ø 125 mm	3	
		K400 Ø 125 mm	4	
		K800 Ø 125 mm	5	
		K1500 Ø 125 mm	6	
		K3000 Ø 125 mm	7	Zacht Doux

code						min.	€
DX 751005		5420000068537	50	125 mm	0,030 kg	1	15,50
DX 751010		5420000068544	100	125 mm	0,030 kg	1	15,50
DX 751020		5420000068551	200	125 mm	0,030 kg	1	15,50
DX 751040		5420000068568	400	125 mm	0,030 kg	1	15,50
DX 751080		5420000068575	800	125 mm	0,030 kg	1	15,50
DX 751150		5420000068582	1500	125 mm	0,030 kg	1	15,50
DX 751300		5420000068599	3000	125 mm	0,030 kg	1	15,50
8-delige set (50 ▶ 3000 + steunschijf) • set de 8 pièces (50 ▶ 3000 + disque de support)							
DX 751908		5420000068612	50 ▶ 3000	125 mm	0,342 kg	1	115,00

STD - SOFT PRO CONSTRUCTION

EN 13236



Abrasieve, zachte voegen
Abrasifs, joints tendre

code									min.	€	
		mm	mm	mm	mm						
DX 714125		5420000024359	125	22,2	7,0	6,35	346 gr	-	1	1	63,20



JC - SOFT PREMIUM CONSTRUCTION

EN 13236



Tandenverzet
Dents alternées

Abrasieve, zachte voegen
Abrasifs, joints tendre

code									min.	€	
		mm	mm	mm	mm						
DX 712125		5420000020580	125	22,2	7,5	8(4+4)	455 gr	-	1	1	96,00



JC - HARD PREMIUM CONSTRUCTION

EN 13236



Harde voegen
Joints durs

Tandenverzet
Dents alternées

code									min.	€	
		mm	mm	mm	mm						
DX 710115		5420000020559	115	22,2	7,5	8(4+4)	368 gr	-	1	1	79,40
DX 710125		5420000020566	125	22,2	7,5	8(4+4)	446 gr	-	1	1	94,50



PRODIAXO QUICK SEARCH 3-STEP

1

BEPAAAL DE BOORAANSLUITING • DÉTERMINER LE RACCORDEMENT DU FORET



M16



M14



R 1/2 "



1 1/4 "

2

NATBOREN OF DROOGBOREN • FORAGE À EAU OU À SEC



Voor gebruik zonder waterkoeling : BAKSTEEN EN ZACHTE STEENSOORTEN
POUR USAGE À SEC : BRIQUES ET PIERRES DOUCES



Voor gebruik met waterkoeling : BETON EN HARDE STEENSOORTEN
POUR LE FORAGE À REFROIDISSEMENT À EAU : BÉTON ET PIERRES DURES

3

BEPAAAL HET KWALITEITSNIVEAU • DÉTERMINER LE NIVEAU DE QUALITÉ

TOP



PREMIUM



PRO



BASIC



LEVENSDUUR / LONGÉVITÉ

PERFORMANCE



**KLOPFUNCTIE NIET GEBRUIKEN
NE PAS UTILISER LA FONCTION PERCUSSION**



DROOGBOREN ZONDER STOF AFZUIGING

FORAGE À SEC SANS ASPIRATION

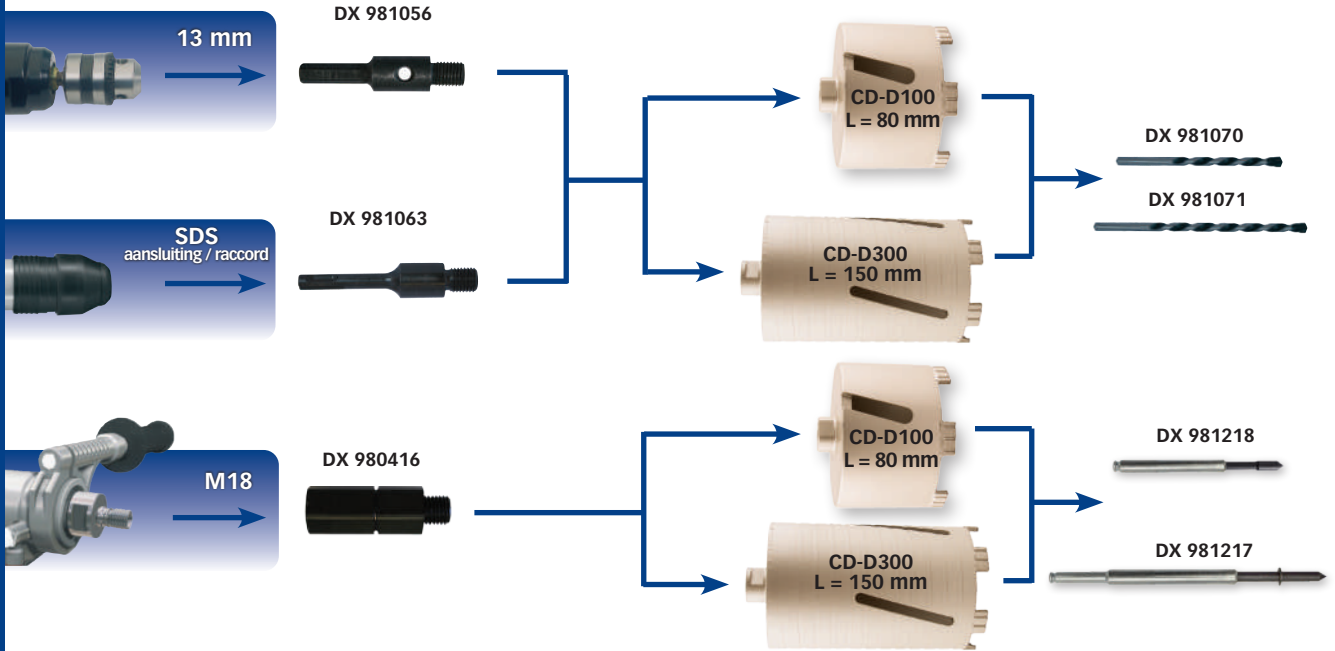

DROOGBOREN MET STOF AFZUIGING

FORAGE À SEC AVEC ASPIRATION

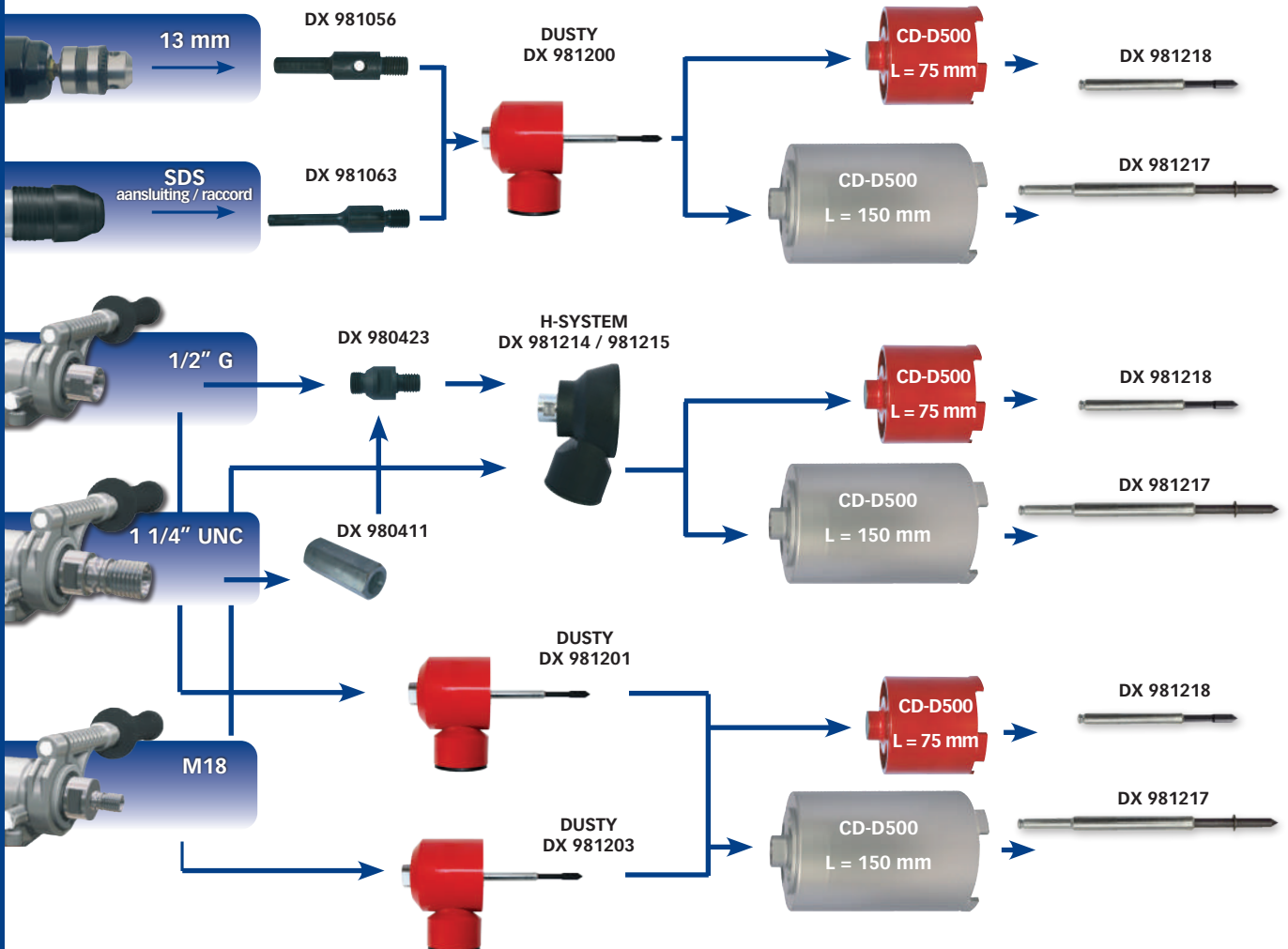

SERIE CD - D150
TOP CONSTRUCTION

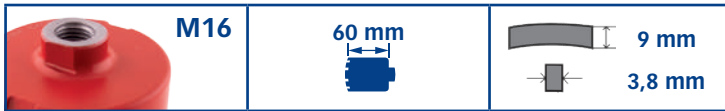

Baksteen • Briques

code			Ø	#				min.	€
			mm						
DX 803268		5420000029675	68	4	416 gr	-	1	1	119,00
DX 803282		5420000029682	82	4	548 gr	-	1	1	135,00
DX 803302		5420000029699	102	5	600 gr	-	1	1	173,00



JAGUAR segment

Very fast - Long-life
Supercooled - Less friction



SERIE CD - D100
PREMIUM CONSTRUCTION

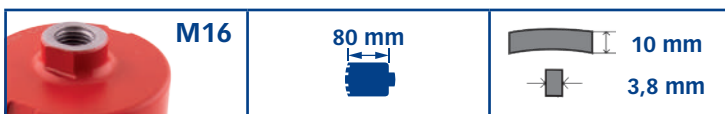

Baksteen • Briques

code			Ø	#				min.	€
			mm						
DX 802068		5420000020627	68	3	433 gr	-	1	1	55,50
DX 802082		5420000020634	82	4	549 gr	-	1	1	69,30
DX 803102		5420000025370	102	6	597 gr	-	1	1	142,00

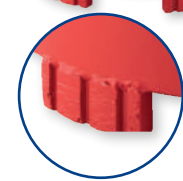

SERIE CD - D300
PREMIUM CONSTRUCTION

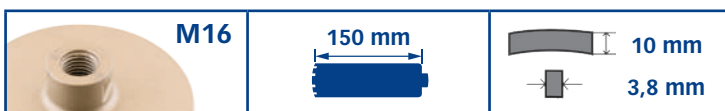

Baksteen • Briques

code			Ø	#				min.	€
			mm						
DX 811052		5420000020658	52	4	448 gr	-	1	1	75,10
DX 811068		5420000020665	68	4	647 gr	-	1	1	82,20
DX 811082		5420000020672	82	5	805 gr	-	1	1	92,80
DX 811102		5420000020689	102	6	1158 gr	-	1	1	118,00
DX 811132		5420000020696	132	6	1761 gr	-	1	1	143,00

DROOGBOREN / COURONNES À SEC

Gebruikt met een stofafzuigsystem / Utilisé avec un système d'extraction de poussière

SERIE CD - D500 PREMIUM CONSTRUCTION



DX 805...

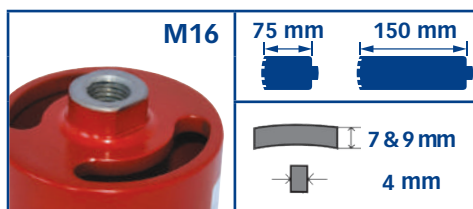

Stofsleuven in deksel voor stofafzuigunit
Rainure d'aspiration dans la flasque pour carter d'aspiration

Baksteen • Briques

code			Ø	#				min.	€
------	--	--	---	---	--	--	--	------	---

L = 75 mm									
DX 805068		5420000022065	68	4	360 gr	-	1	1	111,00
DX 805076		5420000023680	76	4	440 gr	-	1	1	109,00
DX 805082		5420000022072	82	4	475 gr	-	1	1	118,00
DX 805102		5420000020641	102	4	729 gr	-	1	1	147,00
DX 805105		5420000023741	105	4	956 gr	-	1	1	156,00
DX 805132		5420000022423	132	5	1000 gr	-	1	1	227,00

L = 150 mm									
DX 817062		5420000020733	62	4	658 gr	-	1	1	115,00
DX 817072		5420000020740	72	4	807 gr	-	1	1	127,00
DX 817082		5420000020757	82	4	902 gr	-	1	1	133,00
DX 817092		5420000020764	92	4	1271 gr	-	1	1	148,00
DX 817102		5420000020771	102	4	1338 gr	-	1	1	165,00
DX 817112		5420000020788	112	4	1506 gr	-	1	1	180,00
DX 817122		5420000020795	122	4	1700 gr	-	1	1	203,00
DX 817132		5420000022416	132	5	1942 gr	-	1	1	227,00

L = 150 mm									
DX 817030		5420000020702	30	Ø	284 gr	-	1	1	85,00
DX 817040		5420000020719	40	Ø	392 gr	-	1	1	97,30
DX 817052		5420000020726	52	3	619 gr	-	1	1	105,00



DX 817...

DX 817030
DX 817040
DX 817052

Andere diameters of boren met stofgaten op bestelling
Autres diamètres ou couronnes avec trous d'évacuation de la poussière sur demande

Centreeropname met uitdrijving Porte-outil de centrage avec chasse-cône

code								min.	€
DX 981056		5420000021549	6-kant / 6-pans	M16 (M)	150 gr	-	1	1	16,61
DX 981063		5420000021556	SDS+ aansluiting raccord	M16 (M)	150 gr	-	1	1	20,38

Centreerboor voor centreeropname Mèche de centrage pour porte-outil de centrage

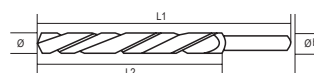

code			Ø	Ø bis	L1	L2				min.	€
DX 981070		5420000021563	8	7	120	70	38 gr	-	1	1	8,72
DX 981071		5420000022607	8	7	250	190	64 gr	-	1	1	23,09



DROOGBOREN / COURONNES À SEC

SYSTEM - H / DUSTY



**Stofafzuignit • Carter d'aspiration
SYSTEM-H**

code							min.	€
DX 981214		5420000024007	M16 (F) / M16 (M)	383 gr	-	1	1	93,30
DX 981215		5420000024014	M18 (F) / M16 (M)	383 gr	-	1	1	93,30

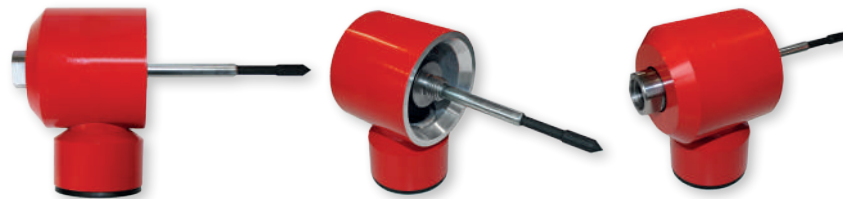

**Stofafzuignit • Carter d'aspiration
DUSTY**

code								min.	€
DX 981200		5420000022317	M16 (F)	M16 (M)	1050 gr	-	1	1	195,00
DX 981201		5420000022324	R 1/2" (M)	M16 (M)	1205 gr	-	1	1	195,00
DX 981203		5420000022614	M18 (F)	M16 (M)	1097 gr	-	1	1	195,00



Centreerpen • Axe de centrage

code								min.	€
DX 981218		5420000033733	8	150	65 gr	-	1	1	32,52
DX 981217		5420000024588	8	230	120 gr	-	1	1	36,29

Door een speciaal afzuigstelsysteem wordt het stof uit het boorgat afgevoerd, dit verhoogt de levensduur van de boorkronen. Snel en gemakkelijk reinigen door gereedschapsloos afnemen van de afzuignit.

Ce système aspire les poussières et prolonge la durée de vie de la couronne de forage. Nettoyage simple et rapide, aucun outil nécessaire lors du démontage de l'unité d'aspiration.

DROOGBOREN / COURONNES À SEC
SERIE CD - D555
PREMIUM GRANITE

70 mm

35 mm

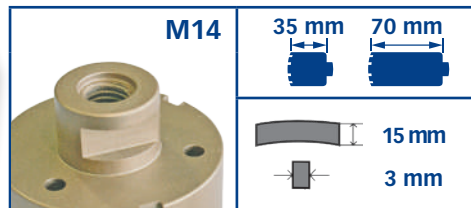
Keramiek, graniet, marmor • Céramique, granite, marbre

code		Ø				min.	€
------	--	---	--	--	--	------	---

mm

L = 35 mm								
DX 801006		5420000037083	6	25 gr	-	1	1	16,40
DX 801008		5420000037090	8	38 gr	-	1	1	18,17
DX 801010		5420000037106	10	42 gr	-	1	1	19,89
DX 801012		5420000037113	12	45 gr	-	1	1	21,10
DX 801014		5420000058750	14	55 gr	-	1	1	22,80
DX 801027		5420000023758	27	114 gr	-	1	1	34,70
DX 801035		5420000023765	35	161 gr	-	1	1	48,60
DX 801040		5420000063464	40	185 gr	-	1	1	54,20
DX 801050		5420000023772	50	222 gr	-	1	1	70,90
DX 801060		5420000023789	60	282 gr	-	1	1	83,80
DX 801068		5420000063341	68	300 gr	-	1	1	84,20
DX 801075		5420000023796	75	351 gr	-	1	1	91,30
DX 801080		5420000034761	80	398 gr	-	1	1	97,10
DX 801083		5420000063358	83	400 gr	-	1	1	101,00
DX 801090		5420000034778	90	459 gr	-	1	1	115,00
DX 801102		5420000027206	102	487 gr	-	1	1	118,00
DX 801112		5420000034785	112	519 gr	-	1	1	141,00
DX 801125		5420000034792	125	588 gr	-	1	1	159,00

L = EXTRA LONG 70 mm								
DX 801527		5420000029453	27	166 gr	-	1	1	44,70
DX 801535		5420000029460	35	209 gr	-	1	1	58,90
DX 801550		5420000029477	50	299 gr	-	1	1	82,80
DX 801560		5420000029484	60	370 gr	-	1	1	99,20
DX 801570		5420000029491	70	439 gr	-	1	1	124,00
DX 801582		5420000029507	82	532 gr	-	1	1	135,00

SETS L = 35 mm
5-delige SET • Jeu de 5 pièces : Ø 27, 35, 50, 60, 75 mm

DX 801000	koffer/coffre	5420000022461	SET	1430 gr	-	1	1	298,00
-----------	---------------	---------------	-----	---------	---	---	---	--------

7-delige SET • Jeu de 7 pièces :
Ø 2 x 6, 2 x 8, 1 x 10, 1 x 12 mm + adapter (DX 981060) • + adaptateur (DX 981060)

DX 800975	koffer/coffre	5420000046825	SET	560 gr	-	1	1	148,00
-----------	---------------	---------------	-----	--------	---	---	---	--------

5-delige SET • Jeu de 5 pièces :
Ø 2 x 6, 2 x 8 mm + adapter (DX 981060) • + adaptateur (DX 981060)

DX 800980	koffer/coffre	5420000046849	SET	458 gr	-	1	1	98,00
-----------	---------------	---------------	-----	--------	---	---	---	-------

Adapter - verloopstuk • Adaptateur - Raccord de réduction

DX 981060		5420000046832	rond • ronde / M14 (M)	150 gr	-	1	1	15,85
-----------	--	---------------	------------------------	--------	---	---	---	-------

DX 981060

DRY CUT
 BY WAX TECHNOLOGY

DX 801000



DX 800975



DROOGBOREN / COURONNES À SEC

**SERIE CD - D555 WAX
TOP GRANITE**



**WAX in de kop van de boor
WAX dans la tête de la couronne**



DX 801999

TOP!

code			Ø				min.	€
			mm					
DX 801904		5420000065055	4	23 gr	-	1	1	16,40
DX 801906		5420000029293	6	23 gr	-	1	1	16,40
DX 801908		5420000029309	8	35 gr	-	1	1	16,40
DX 801910		5420000029316	10	37 gr	-	1	1	16,40
DX 801912		5420000029323	12	40 gr	-	1	1	18,80
6 - delige set • Jeu de 6 pièces								
DX 801999	koffer/coffre	5420000034808	6, 8, 10, 12, 14	713 gr	-	1	1	107,00
			+ guide (inox)					





**Cooling Wax voor droogboren
Cire de refroidissement pour couronnes à sec**

code							min.	€
DX 801985	vrac	5420000062344	20 ml	0,040 kg	-	10	1	4,30



CR-100
PREMIUM CONSTRUCTION

Diamant kantenfrees voor het afronden van porselein, graniet, marmer, keramiek, natuursteen, tegels
 Fraise diamantée pour fraisage du grès cérame, granit, marbre, en céramique, pierre naturelle, carrelage

code			Ø						min.	€
DX 704020		5420000062740	20	50	M14	236 gr	-	1	1	53,60



Diamant puntfrees voor porselein, graniet, marmer, keramiek, natuursteen, tegels
 Fraise à pointe diamantée pour porcelaine, granite, marbre, grès cérame, pierre naturelle, carrelage

NEW





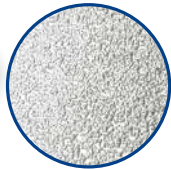

code			Ø						min.	€
DX 704535		5420000069886	5-35	35	M14	120 gr	-	1	1	21,00



Afschuinen en ontbramen
 Chanfreiner et ébavurer



Diamant frees voor porselein, graniet, marmer, keramiek, natuursteen, tegels
 Fraise diamantée pour porcelaine, granite, marbre, grès cérame, pierre naturelle, carrelage

code			Ø						min.	€
DX 704675		5420000069893	35-75	40	M14	850 gr	-	1	1	41,00

NEW

Afschuinen om bestaande gaten te vergroten, slijpen en polijsten
 Biseauter pour agrandir, meuler et polir les trous existants

CD-DI 835 / CUBIX TECH
PREMIUM CONSTRUCTION

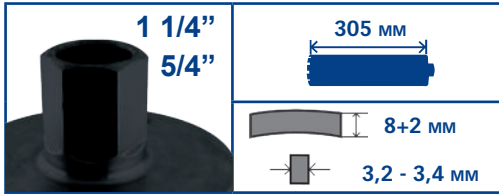

NEW

i Best de boor voorslijpen voor een beter resultaat in wapening
 Affûter les forets pour un meilleur résultat dans le béton armé

SOFT-IMPACT Cubix Tech. Diamant boorkronen
Couronnes diamantés SOFT-IMPACT Cubix Tech.

code			Ø	#			min.	€	
			mm						
DX 835032	vrac	5420000069961	32	5	800 gr	-	1	107,00	
DX 835042	vrac	5420000069978	42	5	880 gr	-	1	107,00	
DX 835052	vrac	5420000069985	52	5	1090 gr	-	1	112,00	
DX 835062	vrac	5420000069992	62	5	1300 gr	-	1	128,00	
DX 835072	vrac	5420000070004	72	6	1510 gr	-	1	138,00	
DX 835076	vrac	5420000070127	76	6	1720 gr	-	1	140,00	
DX 835082	vrac	5420000070011	82	6	1720 gr	-	1	143,00	
DX 835092	vrac	5420000070028	92	6	1930 gr	-	1	152,00	
DX 835102	vrac	5420000070035	102	7	2140 gr	-	1	157,00	
DX 835112	vrac	5420000070042	112	7	2350 gr	-	1	162,00	
DX 835122	vrac	5420000070059	122	8	2560 gr	-	1	180,00	
DX 835132	vrac	5420000070066	132	8	2770 gr	-	1	195,00	
DX 835142	vrac	5420000070073	142	8	2980 gr	-	1	267,00	
DX 835152	vrac	5420000070080	152	8	3190 gr	-	1	289,00	
DX 835162	vrac	5420000070097	162	9	3400 gr	-	1	320,00	

Geschikt voor / Adapté pour :



Beton/gewapend beton zie machine en statief blz. 14 & blz. 22
 Béton/béton armé voir machine et bâti page 14 et page 22



New **CUBIX** Technology

Extra stofverwijdering dankzij de groeven

Extraction supplémentaire de la poussière grâce aux rainures

ALSO FOR REINFORCED CONCRETE

FOR IHT MACHINES

SOFT IMPACT DRY CONCRETE

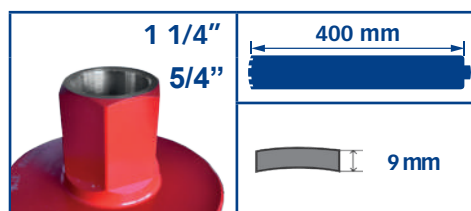
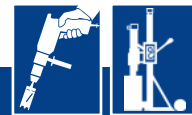

SERIE CD - D800
PREMIUM CONSTRUCTION

NIET GESCHIKT VOOR BETON !
PAS APTE POUR LE BÉTON !

Baksteen hard en middelmatig • Briques durs et demi-dur

code			Ø		#			min.	€	
			mm	mm						
DX 824032	vrac	5420000026438	32	2,5	3	872 gr	-	1	1	89,00
DX 824042	vrac	5420000026445	42	2,5	4	934 gr	-	1	1	101,00
DX 824052	vrac	5420000026452	52	3,5	3	1367 gr	-	1	1	114,00
DX 824062	vrac	5420000026469	62	3,5	4	1722 gr	-	1	1	123,00
DX 824082	vrac	5420000026476	82	3,5	4	2230 gr	-	1	1	142,00
DX 824092	vrac	5420000026483	92	3,5	4	2484 gr	-	1	1	161,00
DX 824102	vrac	5420000026490	102	3,5	4	2750 gr	-	1	1	176,00
DX 824112	vrac	5420000026506	112	3,5	4	3198 gr	-	1	1	195,00
DX 824122	vrac	5420000026513	122	3,5	4	3329 gr	-	1	1	215,00
DX 824132	vrac	5420000026520	132	3,5	5	3965 gr	-	1	1	236,00
DX 824152	vrac	5420000026537	152	3,5	5	4368 gr	-	1	1	293,00
DX 824162	vrac	5420000028784	162	3,5	6	5300 gr	-	1	1	345,00



NATBOREN



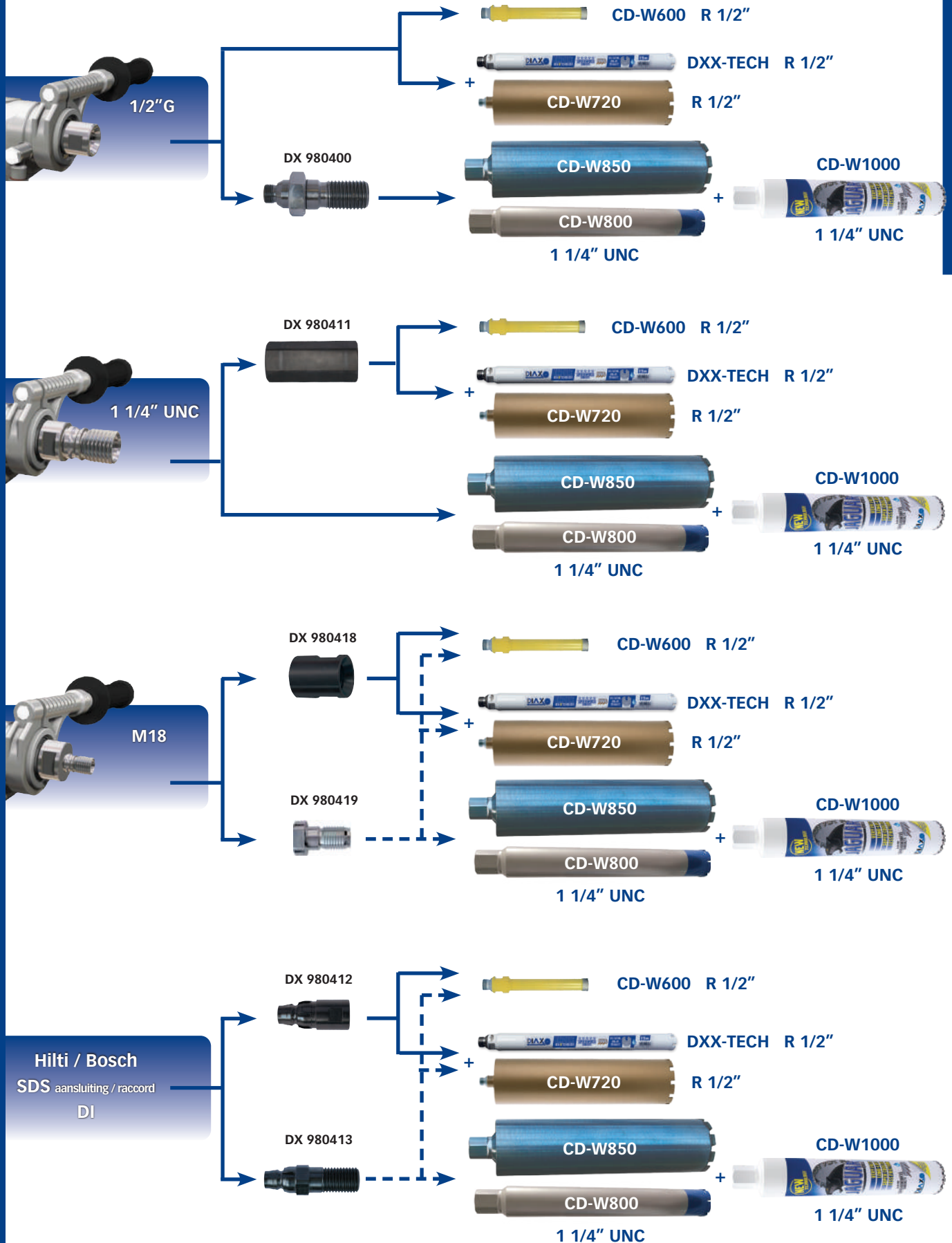



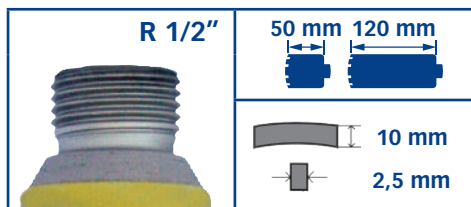
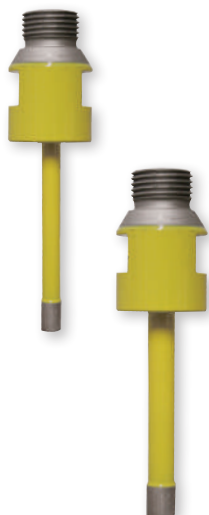











FORAGE À EAU



BOORKRONEN / COURONNES

CD - W600
PREMIUM GRANITE

Graniet • Granite

code			Ø		#				min.	€
			mm	mm						
DX 920006		5420000021389	6,3	50	0	201 gr	-	1	1	62,20
DX 920008		5420000021396	8,3	50	0	200 gr	-	1	1	67,70
DX 920010		5420000021402	10	50	0	202 gr	-	1	1	74,30
DX 920012		5420000021419	12	120	0	219 gr	-	1	1	77,30
DX 920014		5420000021426	14	120	0	215 gr	-	1	1	81,30
DX 920016		5420000021433	16	120	0	192 gr	-	1	1	87,30
DX 920018		5420000021440	18	120	0	206 gr	-	1	1	90,70
DX 920020		5420000021457	20	120	0	203 gr	-	1	1	102,30
DX 920025		5420000021464	25	120	0	233 gr	-	1	1	112,90
DX 920032		5420000021471	32	120	0	280 gr	-	1	1	125,70
DX 920036		5420000021488	36	120	0	314 gr	-	1	1	135,40
DX 920042		5420000021495	42	120	0	347 gr	-	1	1	142,00
DX 920051		5420000021501	51	120	5	554 gr	-	1	1	152,00



Herbezetting boorkronen alle merken (gesoldeerd)
Resegmentation des couronnes de toutes marques (soudé)

Naast het programma in deze brochure van de meest gangbare boren
levert PRODIAZO u ook specifieke boren met afwijkende diameter en / of lengtes op aanvraag

À côté des couronnes qui sont mentionnées de la brochure, il est possible d'en commander avec des diamètres et longueurs différentes, et ceci sur demande



BOORKRONEN MET LASERGELASTE SEGMENTEN COURONNES AVEC SEGMENTS SOUDÉS AU LASER

DXX - TECH TOP CONSTRUCTION

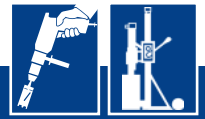
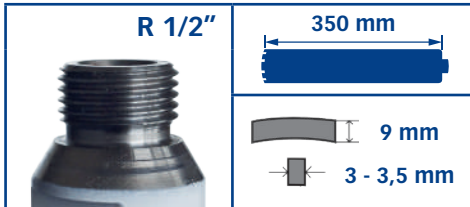

Beton, gewapend beton en aggregaten • Béton, béton armé et agrégats

code			Ø		#				min.	€
			mm	mm						
DX 905018		5420000046207	18	3	3	650 gr	-	1	1	75,30
DX 905020		5420000046214	20	3	4	670 gr	-	1	1	75,30
DX 905022		5420000046221	22	3	4	680 gr	-	1	1	86,00
DX 905025		5420000046238	25	3	5	750 gr	-	1	1	89,60
DX 905028		5420000046245	28	3	6	790 gr	-	1	1	93,20
DX 905030		5420000046252	30	3	6	850 gr	-	1	1	96,80
DX 905032		5420000046269	32	3,5	4	950 gr	-	1	1	114,70
DX 905035		5420000046276	35	3,5	5	980 gr	-	1	1	121,90



Fast cutting
Long-life
Reinforced concrete
Top quality
Good price



CD - W720 PREMIUM CONSTRUCTION

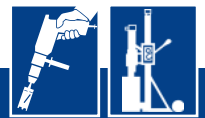
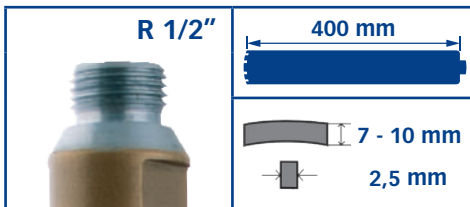

Dunwandig : (gemakkelijk uit de hand boren)
Fine : (facile à utiliser avec machine portative)

Beton, gewapend beton en aggregaten • Béton, béton armé et agrégats





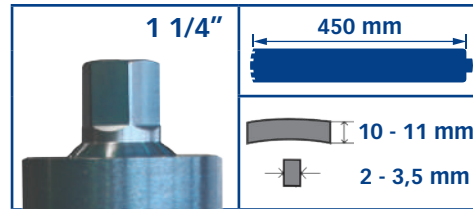

code			Ø		#				min.	€
			mm	mm						
DX 908030		5420000061323	30	7	6	750 gr	-	1	1	91,60
DX 908040		5420000046290	40	7	3	1050 gr	-	1	1	77,90
DX 908046		5420000046306	46	7	6	1150 gr	-	1	1	93,90
DX 908051		5420000046313	51	10	5	1250 gr	-	1	1	98,00
DX 908056		5420000046320	56	10	5	1350 gr	-	1	1	110,20
DX 908061		5420000046337	61	10	6	1450 gr	-	1	1	114,30
DX 908068		5420000046344	68	10	6	1550 gr	-	1	1	155,00
DX 908071		5420000046351	71	10	7	1650 gr	-	1	1	156,00
DX 908076		5420000046368	76	10	7	1750 gr	-	1	1	161,00
DX 908081		5420000046375	81	10	8	1950 gr	-	1	1	166,00
DX 908086		5420000046382	86	10	8	2050 gr	-	1	1	171,00
DX 908091		5420000046399	91	10	9	2150 gr	-	1	1	173,00
DX 908101		5420000046405	101	10	9	2350 gr	-	1	1	185,00
DX 908105		5420000046412	105	10	9	2450 gr	-	1	1	222,00
DX 908111		5420000046429	111	10	10	2550 gr	-	1	1	204,00
DX 908121		5420000046436	121	10	11	2650 gr	-	1	1	220,00
DX 908131		5420000046443	131	10	11	2750 gr	-	1	1	257,00
DX 908151		5420000046450	151	10	13	3550 gr	-	1	1	298,00



BOORKRONEN / COURONNES

CD - W850
PREMIUM CONSTRUCTION

 Dikwandige buis (voor op statief)
 Paroi épaisse (pour trépied)

Beton, gewapend beton (natzagen) • Béton, béton armé (forage à l'eau)

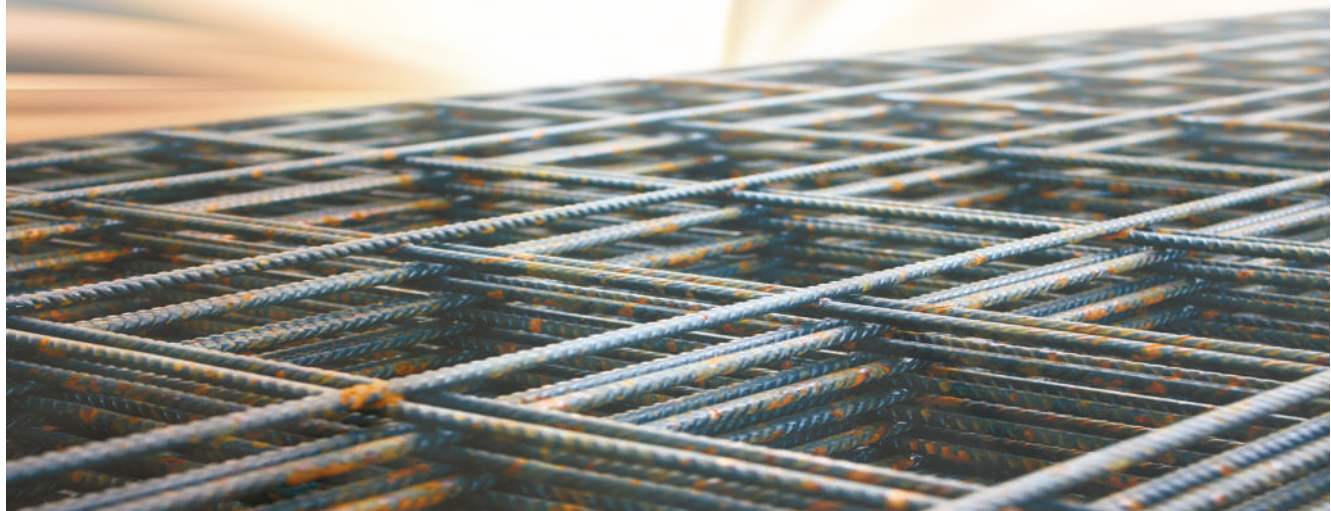
code			Ø		#				min.	€
			mm							
DX 914025	vrac	5420000036741	25	○	600 gr	-	1	1		85,50
DX 914028	vrac	5420000041998	28	○	750 gr	-	1	1		99,80
DX 914030	vrac	5420000036758	30	○	800 gr	-	1	1		92,60
DX 914035	vrac	5420000036765	35	○	900 gr	-	1	1		114,00
DX 914040	vrac	5420000036772	40	5	1200 gr	-	1	1		121,10
DX 914052	vrac	5420000036789	52	5	1600 gr	-	1	1		105,60
DX 914062	vrac	5420000036796	62	6	1800 gr	-	1	1		126,80
DX 914072	vrac	5420000036802	72	7	2200 gr	-	1	1		148,00
DX 914082	vrac	5420000036819	82	7	2400 gr	-	1	1		161,00
DX 914092	vrac	5420000036826	92	8	2700 gr	-	1	1		173,00
DX 914102	vrac	5420000036833	102	9	3100 gr	-	1	1		192,00
DX 914112	vrac	5420000036840	112	9	3400 gr	-	1	1		200,00
DX 914122	vrac	5420000036857	122	10	3600 gr	-	1	1		212,00
DX 914127	vrac	5420000036864	127	10	3900 gr	-	1	1		220,00
DX 914132	vrac	5420000036871	132	11	4100 gr	-	1	1		230,00
DX 914142	vrac	5420000036888	142	11	4600 gr	-	1	1		248,00
DX 914152	vrac	5420000036895	152	12	5700 gr	-	1	1		265,00
DX 914162	vrac	5420000036901	162	13	6100 gr	-	1	1		278,00
DX 914172	vrac	5420000036918	172	13	6400 gr	-	1	1		302,00
DX 914182	vrac	5420000036925	182	14	7100 gr	-	1	1		309,00
DX 914200	vrac	5420000036932	200	15	7800 gr	-	1	1		309,00
DX 914225	vrac	5420000036949	225	16	9100 gr	-	1	1		451,00
DX 914250	vrac	5420000036956	250	17	11000 gr	-	1	1		483,00
DX 914300	vrac	5420000036963	300	22	16500 gr	-	1	1		547,00

**LASERGEST
SODÉS LASER**

BOORKRONEN / COURONNES

CD - W800

PREMIUM CONSTRUCTION

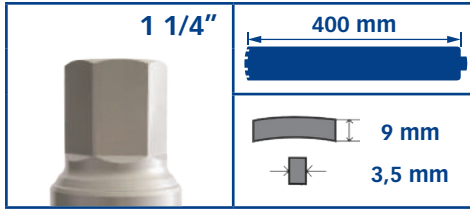

Dikwandige buis (voor op statief)
Paroi épaisse (pour trépied)

Beton, gewapend beton • Béton, béton armé

code			Ø	#			min.	€
			mm					
DX 915350	vrac	5420000021334	350	23	18300 gr	-	1	697,00
DX 915400	vrac	5420000021341	400	28	26900 gr	-	1	922,00
DX 915450	vrac	5420000021358	450	30	32500 gr	-	1	1010,00
DX 915500	vrac	5420000021365	500	30	38700 gr	-	1	1082,00
DX 915600	vrac	5420000021372	600	33	55700 gr	-	1	1055,00



CD - W1000

PREMIUM CONSTRUCTION

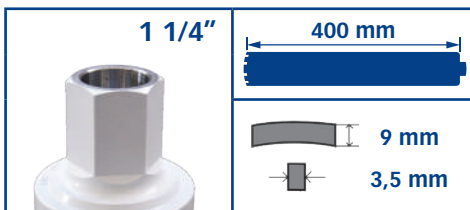

**ALSO FOR SUPER
REINFORCED
CONCRETE !**

Beton, gewapend beton • Béton, béton armé

code			Ø	#			min.	€
			mm					
DX 912052		5420000024816	52	5	1385 gr	-	1	125,00
DX 912057		5420000024823	57	5	1500 gr	-	1	126,30
DX 912062		5420000024830	62	6	1682 gr	-	1	152,00
DX 912067		5420000024847	67	6	1758 gr	-	1	178,00
DX 912072		5420000024854	72	7	2010 gr	-	1	176,00
DX 912082		5420000024878	82	8	2272 gr	-	1	195,00
DX 912087		5420000024885	87	8	2478 gr	-	1	209,00
DX 912092		5420000024892	92	9	2435 gr	-	1	213,00
DX 912102		5420000024908	102	9	2834 gr	-	1	223,00
DX 912112		5420000024915	112	10	3442 gr	-	1	246,00
DX 912122		5420000029064	122	11	3411 gr	-	1	278,00
DX 912132	vrac	5420000029071	132	11	3751 gr	-	1	288,00
DX 912142	vrac	5420000029088	142	12	4573 gr	-	1	298,00
DX 912152	vrac	5420000029095	152	13	5000 gr	-	1	327,00
DX 912160	vrac	5420000029101	160	14	5150 gr	-	1	356,00
DX 912170	vrac	5420000029118	170	14	5150 gr	-	1	363,00
DX 912180	vrac	5420000029125	180	15	6150 gr	-	1	387,00
DX 912200	vrac	5420000029132	200	15	7600 gr	-	1	389,00
DX 912220	vrac	5420000029149	220	17	10800 gr	-	1	560,00
DX 912250	vrac	5420000029156	250	18	13100 gr	-	1	578,00
DX 912300	vrac	5420000029163	300	20	17200 gr	-	1	643,00
DX 912350	vrac	5420000029170	350	23	21800 gr	-	1	763,00



**Very fast
Long-life
Super cooled
Less friction**

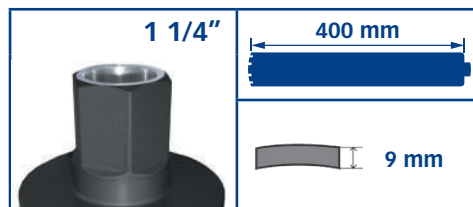
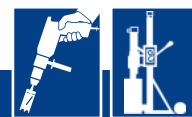

BOORKRONEN / COURONNES
CD - W900 Soft
PREMIUM CONSTRUCTION

Asfalt • Asphalte

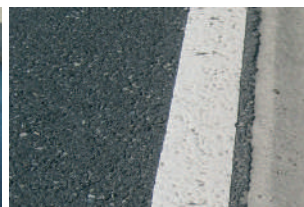
code			Ø		#				min.	€
			mm	mm						
DX 917032	vrac	5420000028791	32	3,3	3	1019 gr	-	1	1	94,40
DX 917042	vrac	5420000028807	42	3,3	4	938 gr	-	1	1	104,60
DX 917047	vrac	5420000028814	47	4	4	1265 gr	-	1	1	113,10
DX 917062	vrac	5420000028821	62	4	6	1711 gr	-	1	1	149,00
DX 917082	vrac	5420000028838	82	4	8	2262 gr	-	1	1	191,00
DX 917092	vrac	5420000028845	92	4	9	2509 gr	-	1	1	215,00
DX 917102	vrac	5420000028852	102	4	10	2862 gr	-	1	1	234,00
DX 917112	vrac	5420000025295	112	4	11	3203 gr	-	1	1	262,00
DX 917122	vrac	5420000028869	122	4	12	3415 gr	-	1	1	286,00
DX 917132	vrac	5420000028876	132	4	12	3781 gr	-	1	1	309,00

SPECIAL ASPHALT

TEGELBOREN / FORETS SPECIALE CARRELAGE

CD - W200

PREMIUM CERAMICS



Harde materialen: graniet, keramiek, porselein, glas, ...
Matériaux durs: granite, céramique, porcelaine, verre, ...

code			Ø				min.	€
			mm					
DX 895005		5420000027220	5	22 gr	-	1	1	11,80
DX 895006		5420000027237	6	23 gr	-	1	1	11,80
DX 895008		5420000027244	8	25 gr	-	1	1	14,00
DX 895010		5420000027251	10	27 gr	-	1	1	15,60
DX 895012		5420000027268	12	31 gr	-	1	1	16,50
DX 895015		5420000029248	15	35 gr	-	1	1	20,30
DX 895020		5420000029255	20	47 gr	-	1	1	26,60
DX 895025		5420000029262	25	56 gr	-	1	1	33,00
DX 895030		5420000029279	30	66 gr	-	1	1	39,40
DX 895035		5420000029286	35	80 gr	-	1	1	45,70

DIAMOND DRILL KIT Premium Ceramics : Ø 5, 6, 8, 10, 12 mm + GUIDE

DX 895200	koffer/coffre	5420000027275	SET	345 gr	-	1	1	88,30
-----------	---------------	---------------	-----	--------	---	---	---	--------------



CD - W200

BASIC CERAMICS



Harde materialen: graniet, keramiek, porselein, glas, ...
Matériaux durs: granite, céramique, porcelaine, verre, ...

code							min.	€
------	--	--	--	--	--	--	------	---

DIAMOND DRILL KIT Basic Ceramics : Ø 5, 6, 8, 10, 12 mm + GUIDE

DX 896395	koffer/coffre	5420000029644	SET	322 gr	-	1	1	35,60
-----------	---------------	---------------	-----	--------	---	---	---	--------------



TOEBEHOREN VOOR TEGELBOREN
ACCESSOIRES POUR FORETS SPECIALE CARRELAGE

 Ø4 - Ø5 - Ø6 - Ø7
 Ø8 - Ø10 - Ø12
 Ø20 - Ø35 mm

 5/32" - 3/16" - 1/4"
 9/32" - 1/2" - 3/8"
 5/16" - 3/4" - 13/8"

Universele metalen boorgeleider met zuignap
Guide métallique de forage universel avec ventouse

code							min.	€
DX 894000		5420000065031	Ø 4 → 35 mm	750 gr	12	6	1	28,50

Kan gekoppeld worden aan een waterkoelingsysteem.
 Peut être connecté à un système de refroidissement à eau.

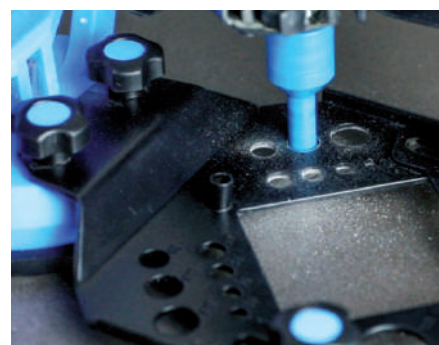
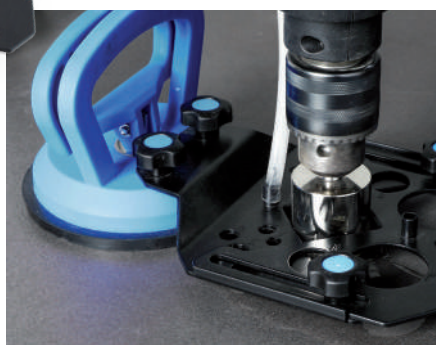
TOEBEHOREN VOOR BOORTECHNIEK
ACCESSOIRES POUR LES TECHNIQUES DE FORAGE
PROFI
4,00 m
Werkdruk • Pression de travail : 3 bar

- Drukreservoir voor watertoevoerapparaat •
- Reservoir : polyethyleen •
- Afdichting NBR •
- Réservoir d'eau sous pression •
- Réservoir : polyéthylène •
- Joints NBR •





DX 982000

FERROX PLUS
2,50 m
Werkdruk • Pression de travail : 6 bar
Draagbaar op de rug • Transport dorsal

- Drukreservoir voor water
- Reservoir : staal / polyester
- Afdichting NBR
- Réservoir d'eau sous pression
- Réservoir : acier / polyester
- Joints NBR

DX 982850

Waterdrukvat voor watertoevoerapparaat
Reservoir à eau sous pression pour dispositif d'approvisionnement en eau

code								min.	€
DX 982000		5420000023178	PROFI	10 L	3424 gr	30	1	1	97,90
DX 982850		5420000023185	FERROX PLUS	10 L	6100 gr	-	1	1	221,00

TOEBEHOREN VOOR BOORTECHNIEK ACCESSOIRES POUR LES TECHNIQUES DE FORAGE

Droogboren / Couronnes à sec



Centreeropname met uitdrijfwig • Porte-outil de centrage avec chasse-cône

code								min.	€
DX 981056			6-kant / 6-pans	M16 (M)	150 gr	-	1	1	16,61
DX 981063			SDS+ aansluiting raccord	M16 (M)	150 gr	-	1	1	20,38

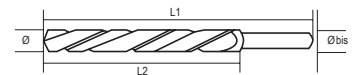

Centreerboor voor centreeropname • Mèche de centrage pour porte-outil de centrage

code			Ø	Ø bis	L1	L2				min.	€
			mm	mm	mm	mm					
DX 981070			8	7	120	70	38 gr	-	1	1	8,72
DX 981071			8	7	250	190	64 gr	-	1	1	23,09

Adapter - verloopstuk • Raccord de réduction



code								min.	€
DX 981060			6-kant / 6-pans	M14 (M)	150 gr	-	1	1	15,85
DX 980415			M18 (F)	M14 (M)	128 gr	-	1	1	55,60
DX 980416			M18 (F)	M16 (M)	179 gr	-	1	1	35,81
DX 980423			R 1/2" (M)	M18 (M)	191 gr	-	1	1	57,90



System-H stofafzuigunit • System-H carter d'aspiration

code								min.	€
DX 981214			M16 (F)	M16 (M)	383 gr	-	1	1	93,30
DX 981215			M18 (F)	M16 (M)	383 gr	-	1	1	93,30

Dusty stofafzuigunit incl. centreerpen • Carter d'aspiration, axe de centrage incl.



code								min.	€
DX 981200			M16 (F)	M16 (M)	1050 gr	-	1	1	195,00
DX 981201			R 1/2" (M)	M16 (M)	1205 gr	-	1	1	195,00
DX 981203			M18 (F)	M16 (M)	1097 gr	-	1	1	195,00

Centreerpen • Axe de centrage



code			Ø					min.	€
			mm	mm					
DX 981218			8	150	65 gr	-	1	1	32,52
DX 981217			8	230	120 gr	-	1	1	36,29

TOEBEHOREN VOOR BOORTECHNIEK
ACCESSOIRES POUR LES TECHNIQUES DE FORAGE

Natboren / Couronnes à eau

Adapter - verloopstuk • Raccord de réduction

	code								min.	€
	DX 980428		542000022140	6-kant / 6-pans	R 1/2" (F)	187 gr	-	1	1	40,65
	DX 980429		542000022157	SDS+ aansluiting / raccord	R 1/2" (F)	175 gr	-	1	1	40,65
	DX 980422		542000027411	R 1/2" (M)	M16x2 (M)	134 gr	-	1	1	15,57
	DX 980400		542000021525	R 1/2" (M)	1 1/4" UNC (M)	531 gr	-	1	1	29,81
	DX 980411		542000021532	1 1/4" UNC (F)	R 1/2" (F)	648 gr	-	1	1	29,81
	DX 980401		542000027565	R 1/2" (F)	1 1/4" (M)	430 gr	-	1	1	50,80
	DX 980417		542000022119	M16 (F)	R 1/2" (F)	142 gr	-	1	1	34,76
	DX 980418		542000022638	M18 (F)	R 1/2" (F)	218 gr	-	1	1	32,05
	DX 980419		542000022645	M18 (F)	R 1/2" (F) 1 1/4" UNC (M)	369 gr	-	1	1	41,64
	DX 980412		542000022089	Hilti / Bosch DD-Bi	R 1/2" (F)	312 gr	-	1	1	40,65
	DX 980413		542000022096	Hilti / Bosch DD-Bi	R 1/2" (F) 1 1/4" UNC (M)	421 gr	-	1	1	52,20
	DX 980420		542000022126	SDS-DI NASTROC Carat	R 1/2" (F) 1 1/4" UNC (M)	458 gr	-	1	1	32,03
	DX 980421		542000022133	NASTROC Carat	R 1/2" (F) M30x2 (M)	276 gr	-	1	1	26,86
	DX 980435		542000058910	NASTROC Carat	1 1/4" UNC (F) M30x2 (M)	300 gr	-	1	1	39,50

TOEBEHOREN VOOR BOORTECHNIEK
ACCESSOIRES POUR LES TECHNIQUES DE FORAGE
Natboren / Couronnes à eau
Verlengstukken • Rallonges

code								min.	€
				mm					
DX 985651		5420000025776	M16	200	342 gr	-	1	1	70,50
DX 985551		5420000025127	M18	200	342 gr	-	1	1	70,80
DX 985541		5420000022201	R 1/2"	200	895 gr	-	1	1	31,70
DX 985542		5420000022218	R 1/2"	300	1350 gr	-	1	1	45,20
DX 985543		5420000022225	R 1/2"	400	1798 gr	-	1	1	51,90
DX 985546		5420000022232	1 1/4" UNC (M)	200	1996 gr	-	1	1	34,00
DX 985547		5420000022249	1 1/4" UNC (M)	300	3066 gr	-	1	1	45,50
DX 985548		5420000022256	1 1/4" UNC (M)	400	4123 gr	-	1	1	56,50
DX 985549		5420000022263	1 1/4" UNC (M)	500	5000 gr	-	1	1	70,90

M16



1/2" G



1 1/4" UNC

Waterspoelkop • Tête à eau

code								min.	€
DX 980603	vrac	5420000022294	M16 (F)	R 1/2" (F)	830 gr	-	1	1	190,00
DX 980604	vrac	5420000022300	3-kant / 3-pans	R 1/2" (F)	820 gr	-	1	1	102,20

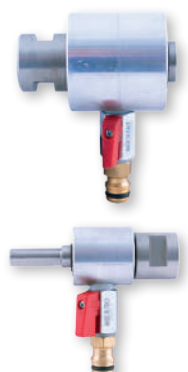

EGO PLUS STEENZAAG • SCIE À PIERRE

Spray system
DISK'S LUBRICATION

ORIGINAL WATER RECYCLING PUMP

DIAXO
WWW.DIAXO.COM

 Inclusief schijf.
 Disque inclus.
 1 x DX 112351

EGO PLUS

	3Hp / 2,2Kw 9A 230V / 50Hz
	13 A
	2800
	300 mm / 25,4 mm 350 mm / 25,4 mm incl. DX 112351
	800 mm
	Ø 300 mm : 230 x 230 mm Ø 350 mm : 405 x 405 mm
	Ø 300 mm : 80 mm Ø 350 mm : 110 mm
	Ø 300 mm : 60 mm Ø 350 mm : 80 mm
	125 mm
	-
	✓
	type P0

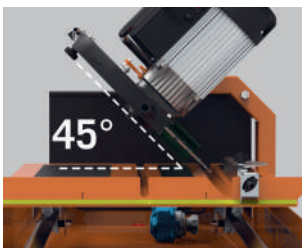
 Zaagkop kantelbaar voor
 verstekzagen van 45° tot 90°.

 Tête inclinable pour les découpes
 d'onglets, de 45° à 90°.

 Kantelbare snijkop voor snellere en
 preciezere uitvoering van speciale
 snedes. Kan op de gewenste hoogte
 worden vergrendeld.

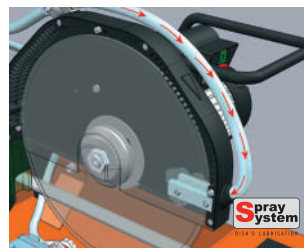
 Tête de coupe inclinable pour une
 exécution plus rapide et plus précise
 des coupes spéciales. Peut être
 verrouillé à la hauteur souhaitée.

 Gepatenteerd systeem dat
 de smering verbetert van
 diamantschijven en zorgt voor
 hogere prestaties en een langere
 levensduur van de bladen.

 Système breveté qui améliore
 la lubrification des lames
 diamantées et assure une meilleure
 performance et une plus longue
 durée de vie des lames.

 Werktafel met glijdende slede
 voorzien van 6 verstelbare nylon
 wielen en 8 kogellagers om een
 perfecte precisie, stabiliteit en
 glijvermogen.

 Table de travail avec chariot
 coulissant équipé de 6 roues en
 nylon réglables et de 8 roulements
 à billes pour une précision, une
 stabilité et un glissement parfait.

code							min.	€
BP 8000J		802141006204	EGO PLUS	62,000 kg	1	-	1	1450,00

ELITE 80 S STEENZAAG • SCIE À PIERRE

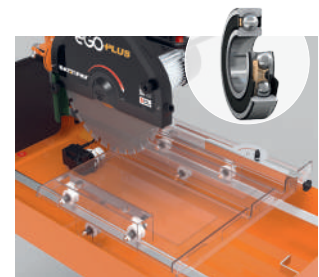
ELITE 80 S

	3Hp / 2,2Kw 9A 230V / 50Hz
	13 A
	2800
	350 mm / 25,4 mm incl. DX 290351
	800 mm
	435 x 435 mm
	110 mm
	80 mm
	130 mm
	✓
	✓
	type P2



Inclusief schijf.
Disque inclus.
1 x DX 290351



ORIGINAL WATER RECYCLING PUMP



LEG FASTENING SYSTEM



WATER DECANTING SYSTEM



DISK'S LUBRICATION



Zaagkop kantelbaar voor verstekzagen van 45° tot 90°.
Tête inclinable pour les découpes d'onglets, de 45° à 90°.



Kantelbare snijkop voor snellere en precieuzere uitvoering van speciale snedes. Kan op de gewenste hoogte worden vergrendeld.
Tête de coupe inclinable pour une exécution plus rapide et plus précise des coupes spéciales. Peut être verrouillé à la hauteur souhaitée.

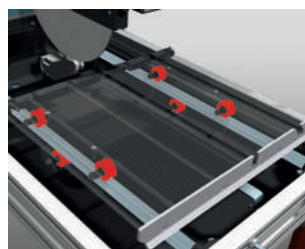

Werktafel met glijdende slede voorzien van 6 verstelbare nylon wielen en 12 kogellagers voor een perfecte precisie, stabiliteit en glijvermogen.
Table de travail avec chariot coulissant équipé de 6 roues en nylon réglables et de 12 roulements à billes pour une précision, une stabilité et un glissement parfait.



BEDIENINGSPANEEL
- Veiligheidsschakelaar met minimumspanningsspoel
- Stroomonderbreker met manuele reset in geval van vastlopen van de schijf
- Rood controlelampje voor werking machine.

PANNEAU DE COMMANDE
- Interrupteur de sécurité avec bobine de tension minimale
- Disjoncteur avec réarmement manuel en cas de blocage du disque
- Témoin lumineux rouge pour le fonctionnement de la machine



code							min.	€
BP 9001		8021410090018	ELITE 80 S	73,000 kg	3	1	1	1950,00
Set wielen • Roues en kit								
BP 90102R		8021410044073	-	4,870 kg	-	1	1	85,00
Set zwenkwielen • Kit de roues pivotantes								
BP 90176R		8021410067652	-	7,000 kg	-	1	1	180,00



EXPERT STEENZAAG • SCIE À PIERRE

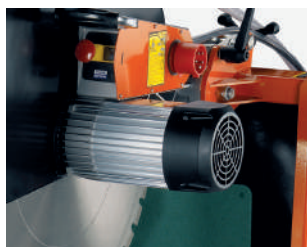

	EXPERT 400S	EXPERT 500S	EXPERT 600XL	EXPERT 700
	3,8Hp / 2,8Kw 12A 230V / 50HZ	4,5Hp / 3,5Kw 16A 230V / 50HZ	4,5Hp / 3,5Kw 16A 230V / 50-60HZ	5,5Hp / 4Kw 8A 400V / 50/60HZ
	16 A	10-16 A	16-20 A	10-16 A
	2800	1400 / 1700	1400 / 1700	1400 / 1700
	400 mm / 25,4 mm incl. DX 290401	500 mm / 25,4 mm incl. DX 115501	600 mm / 25,4 mm incl. DX 115601	700 mm / 25,4 mm incl. DX 115701
	570 mm	750 mm	750 mm	550 mm
	395 x 395 mm	412 x 412 mm	412 x 412 mm	389 x 389 mm
	135 mm	170 mm	220 mm	270 mm
	155 mm	235 mm	285 mm	340 mm
	✓	✓	-	-
	✓	✓	✓	✓
	type P2	type P3	type P3	type P3

BEDIENINGSPANEEL

- Schakelaar met ontgrendelingspoel
- Oververhittingsbeveiliging in geval van vastlopen van de schijf
- Drukknop om de machine te stoppen.

PANNEAU DE COMMANDE

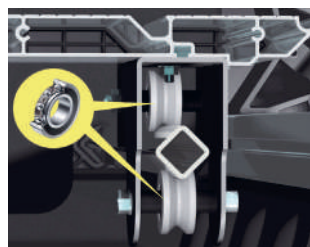
- Interrupteur avec bobine de déverrouillage
- Protection contre la surchauffe en cas de blocage du disque
- Bouton poussoir pour arrêter la machine.



De werktafel is zeer sterk en stabiel.

- Hij schuift op 2 stalen vierkante rails met 6 wielen; 4 boven en 2 onder.
- Elk wiel heeft 2 kogellagers voor een totaal van 12.

La table de travail est très solide et stable.

- Elle glisse sur 2 rails carrés en acier avec 6 roues; 4 au dessus et 2 en dessous.
- Chaque roue comporte 2 roulements à billes, soit un total de 12.



De slijkop is kantelbaar en kan op de gewenste hoogte worden vergrendeld.

La tête de coupe est inclinable et peut être bloquée à la hauteur souhaitée.



De slijpositie met glijdende slede.

La position de coupe avec chariot coulissant.

BP 90102R

BP 90176R

code							min.	€
BP 9401		8021410061346	EXPERT 400S	78,000 kg	3	1	1	2400,00
BP 9501/M		8021410065405	EXPERT 500S	85,000 kg	2	1	1	2835,00
BP 9620/M		8021410067737	EXPERT 600XL	86,000 kg	2	1	1	3100,00
BP 9700		8021410044134	EXPERT 700	100,000 kg	2	1	1	3600,00
Set wielen • Roues en kit								
BP 90102R		8021410044073	-	4,870 kg	-	1	1	85,00
Set zwenkwielen • Kit de roues pivotantes								
BP 90176R		8021410067652	-	7,000 kg	-	1	1	180,00

PRIME STEENZAAG • SCIE À PIERRE

	PRIME 100S	PRIME 120S	PRIME 150S	PRIME 200S
	3Hp / 2,2Kw 9A 230V / 50Hz	3Hp / 2,2Kw 9A 230V / 50Hz	3Hp / 2,2Kw 9A 230V / 50Hz	3Hp / 2,2Kw 9A 230V / 50Hz
	13 A	13 A	13 A	13 A
	2800	2800	2800	2800
	350 mm / 25,4 mm incl. DX 330351	350 mm / 25,4 mm incl. DX 330351	350 mm / 25,4 mm incl. DX 330351	350 mm / 25,4 mm incl. DX 330351
	1000 mm	1200 mm	1500 mm	2000 mm
	705 x 705 mm	845 x 845 mm	1060 x 1060 mm	1410 x 1410 mm
	110 mm	110 mm	110 mm	110 mm
	180 mm	180 mm	180 mm	180 mm
	80 mm	80 mm	80 mm	80 mm
	✓	✓	✓	✓
	✓	✓	✓	✓
	type P3	type P3	type P3	type P3



Inclusief schijf.
Disque inclus.
1 x DX 330351



ORIGINAL WATER RECYCLING PUMP



WATER DECONTAMINATING SYSTEM



LEG FASTENING SYSTEM



DISK'S LUBRICATION



BP 90241



Zaagkop kantelbaar voor verstekzagen van 45° tot 90°.
Tête inclinable pour les découpes d'onglets, de 45° à 90°.

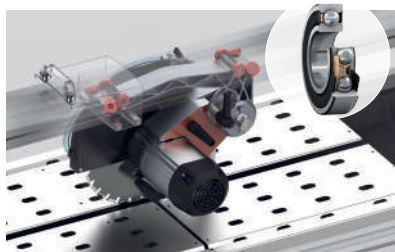

De motorgroepwagen glijdt met 8 kogellagers over verwisselbare roestvrijstalen rails.
Le chariot motorisé glisse sur des rails remplaçables en acier inoxydable avec 8 roulements à billes.



Het snijvoortgangssysteem met handwiel past de beweging van de snijkop naar voren of naar achteren aan.
Le système d'avancement de la coupe avec manivelle permet de régler le mouvement de la tête de coupe vers l'avant ou vers l'arrière.

code							min.	€
BP 91001		8021410023344	PRIME 100S	97,000 kg	3	1	1	2560,00
BP 91201		8021410023771	PRIME 120S	105,000 kg	3	1	1	2730,00
BP 91501		8021410024044	PRIME 150S	127,000 kg	3	1	1	2995,00
BP 92001		8021410054959	PRIME 200S	143,000 kg	3	1	1	3400,00

B-LOCK tegelvergrendelingssysteem • Système de verrouillage des carreaux B-LOCK

● BP 90262U		8021410067645	-	1,100 kg	-	1	1	120,00
-------------	--	---------------	---	----------	---	---	---	--------

Verlengde zijtafel • Table latéral prolongé

BP 90241		8021410022132	60 x 50 cm	8,500 kg	-	1	1	172,00
----------	--	---------------	------------	----------	---	---	---	--------

Set wielen • Roues en kit

BP 90102R		8021410044073	-	4,870 kg	-	1	1	85,00
-----------	--	---------------	---	----------	---	---	---	-------

Set zwenkwielen • Kit de roues pivotantes

BP 90176R		8021410067652	-	7,000 kg	-	1	1	180,00
-----------	--	---------------	---	----------	---	---	---	--------



BP 90262U



BP 90102R

BP 90176R

VIP TEGELZAAG • SCIE POUR CARRELAGE



Inclusief schijf.
Disque inclus.

VIP 290

VIP 2125

	1,3Hp / 1,0Kw 4,5A 230V / 50Hz	1,8Hp / 1,4Kw 6A 230V / 50Hz
	2800	2800
	200 mm / 25,4 mm incl.	200 mm / 25,4 mm incl.
	900 mm	1250 mm
	635 x 635 mm	880 x 880 mm
	40 mm	40 mm
	40 mm	35 mm
	55 mm	55 mm
	-	-
	-	-
	type P0	type P2/4

Shuko

Shuko



ORIGINAL WATER RECYCLING PUMP



DISK'S LUBRICATION



De motorgroepwagen glijdt met 8 kogellagers over verwisselbare roestvrijstalen rails.

Le chariot motorisé glisse sur des rails remplaçables en acier inoxydable avec 8 roulements à billes.



De snijkop is voorzien van een invalzaagsysteem en kan op de gewenste zaagdiepte worden vergrendeld. Hij maakt elke gewenste vorm mogelijk.

La tête de coupe est munie d'un système plongeant et peut être verrouillée à la profondeur voulue. Elle permet de réaliser toutes les formes souhaitées.

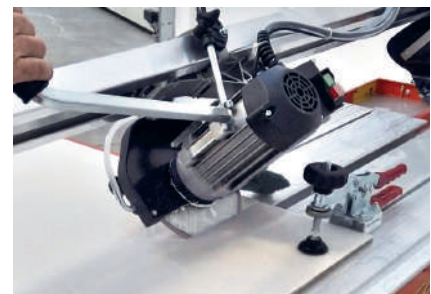

Zaagkop kantelbaar voor verstekzagen van 45° tot 90°.

Tête inclinable pour les découpes d'onglets, de 45° à 90°.

NEW



BP 90262U



BP 85015



code							min.	€
BP 855		8021410008556	VIP 290	40,000 kg	8	1	1	1190,00
BP 857		8021410065863	VIP 2125	51,000 kg	4	1	1	1620,00
B-LOCK tegelvergrendelingsysteem • Système de verrouillage des carreaux B-LOCK								
BP 90262U		8021410067645	-	1,100 kg	-	1	1	120,00
Verlengde zijtafel • Table latéral prolongé								
BP 85015		8021410850155	-	7,000 kg	-	1	1	145,00

CLASS S / CLASS PLUS TEGELZAAG • SCIE POUR CARRELAGE

	CLASS 900 S	CLASS PLUS 1050 S	CLASS PLUS 1300 S
	1,3Hp / 1,0Kw 4,5A 230V / 50Hz	1,8Hp / 1,4Kw 6A 230V / 50Hz	1,8Hp / 1,4Kw 6A 230V / 50Hz
	2800	2800	2800
	200 mm / 25,4 mm incl.	250 mm / 25,4 mm incl.	250 mm / 25,4 mm incl.
	900 mm	≤ 42 mm : 1050 mm > 42 mm : 910 mm	≤ 42 mm : 1300 mm > 42 mm : 1160 mm
	635 x 635 mm	≤ 42 mm : 740 x 740 mm > 42 mm : 645 x 645 mm	≤ 42 mm : 920 x 920 mm > 42 mm : 820 x 820 mm
	40 mm	65 mm	65 mm
	40 mm	53 mm	53 mm
	55 mm	80 mm	80 mm
	✓	✓	✓
	✓	✓	✓
	type P0	type P0	type P2/4

Shuko

Shuko

Shuko



De motorgroepwagen glijdt met 8 kogellagers over verwisselbare roestvrijstalen rails.

Le chariot motorisé glisse sur des rails remplaçables en acier inoxydable avec 8 roulements à billes.

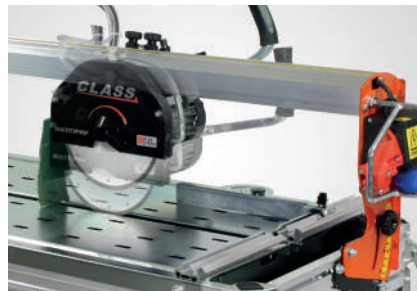

De snijkop is voorzien van een invalzaagsysteem en kan op de gewenste zaagdiepte worden vergrendeld. Hij maakt elke gewenste vorm mogelijk.

La tête de coupe est munie d'un système plongeant et peut être verrouillée à la profondeur voulue. Elle permet de réaliser toutes les formes souhaitées.

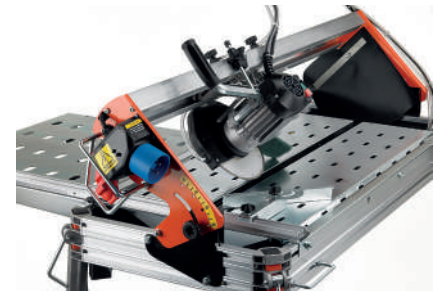

Zaagkop kantelbaar voor verstekzagen van 45° tot 90°.

Tête inclinable pour les découpes d'onglets, de 45° à 90°.



code							min.	€
BP 65901		8021410044646	CLASS 900 S	46,000 kg	3	1	1	1790,00
BP 661101		8021410062329	CLASS PLUS 1050 S	52,000 kg	3	1	1	1910,00
BP 661351		8021410064057	CLASS PLUS 1300 S	58,500 kg	3	1	1	2200,00

B-LOCK tegelvergrendelingssysteem • Système de verrouillage des carreaux B-LOCK

	BP 90262U		8021410067645	-	1,100 kg	-	1	1	120,00
--	-----------	--	---------------	---	----------	---	---	---	--------

Verlengde zijtafel • Table latéral prolongé

	BP 70241		8021410044684	60 x 50 cm	9,000 kg	-	1	1	178,00
--	----------	--	---------------	------------	----------	---	---	---	--------

Set wielen • Roues en kit

	BP 70102R		8021410044707	-	4,000 kg	-	1	1	68,00
--	-----------	--	---------------	---	----------	---	---	---	-------



TOEBEHOREN VOOR ELEKTRISCHE TAFELZAAGMACHINES
ACCESSOIRES POUR LES SCIÉS SUR TABLE ÉLECTRIQUE

ORIGINAL WATER RECYCLING PUMP



	P0	P2	P2/4	P3
Vermogen <i>Puissance</i>	35W	55W	55W	60W
Kabellengte <i>Kabellengte</i>	2,2 m	2,2 m	4 m	2,2 m
Isolatieklasse <i>Classe d'isolation</i>	F	F	F	F
IP	X8	X8	X8	X8
Bereik <i>Gamme</i>	230V-50hz	700 l/h	1000 l/h	1000 l/h
	230V-60hz	700 l/h	950 l/h	950 l/h

REF.	MACHINE	TYPE
BP 8000J	EGO PLUS	P0
BP 9001	ELITE 80	P2
BP 9401	EXPERT 400S	P2
BP 9501/M	EXPERT 500S	P3
BP 9620/M	EXPERT 600XL	P3
BP 9700	EXPERT 700	P3
BP 91001	PRIME 100S	P3
BP 91201	PRIME 120S	P3
BP 91501	PRIME 150S	P3
BP 92001	PRIME 200S	P3
BP 855	VIP 290	P0
BP 857	VIP 2125	P2/4
BP 65901	CLASS 900	P0
BP 661101	CLASS PLUS 1050	P0
BP 661351	CLASS PLUS 1300	P2/4

Waterpomp • Pompes à eau

code							min.	€
BP P0		5420000066557	P0	0,990 kg	-	1	1	80,70
BP P2		5420000066564	P2	1,130 kg	-	1	1	67,90
BP P2/4		5420000066571	P2/4	1,150 kg	-	1	1	85,10
BP P3		8021410030076	P3	1,416 kg	-	1	1	77,00

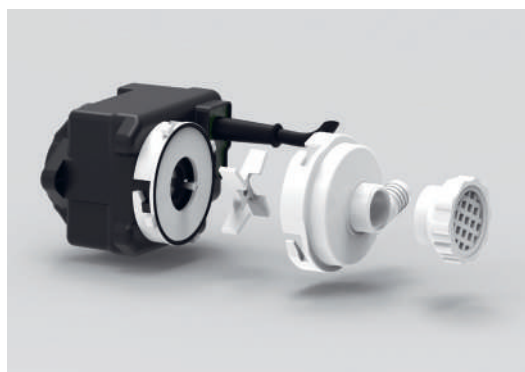
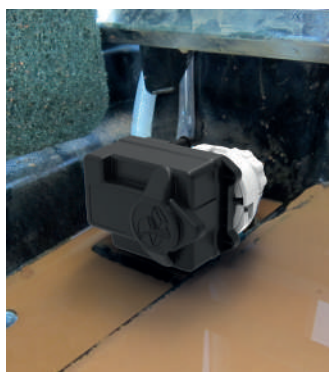
TOEBEHOREN VOOR WATERPOMP
ACCESSOIRES POUR LES POMPES À EAU

BP SPS203

Aanzuigset (compleet mondstuk voor P0 + turbine + O-ring)
Kit d'aspiration (buse complète pour P0 + turbine + joint torique)

BP SPS003		8021410054034	voor/pour P0/P1	0,100 kg	-	1	1	6,17
-----------	--	---------------	-----------------	----------	---	---	---	-------------

Aanzuigset (compleet mondstuk voor P2/P3 + turbine)
Kit d'aspiration (buse complète pour P2/P3 + turbine)

BP SPS203		8021410054041	voor/pour P2/P3	0,100 kg	-	1	1	8,35
-----------	--	---------------	-----------------	----------	---	---	---	-------------